



**AGRÍCOLA  
NAVARRO**



**CATÁLOGO  
GENERAL**

Fábrica de  
cuchillas y  
recambios  
agrícolas

Factory of blades  
and agricultural  
spare parts



# ÍNDICE

<b>Introducción</b> Introduction / Introduction .....	1
<b>Cuchillas</b> Cutting blades / Lames .....	12
<b>Cuchillas triturador</b> Crusher blades / Lames broyeur .....	78
<b>Cuchillas desbrozadoras</b> Brushcutters blades / Lames débroussailleuses .....	84
<b>Martillos de trituradora</b> Crusher hammers / Marteaux de machine à broyer .....	88
<b>Fresas para motoazadas y motocultores</b> Tillage implements for motor hoes and walking tractors / Fraises pour motobineuses et motoculteurs .....	98
<b>Accesorios para motoazadas y motocultores</b> Implement accesories for motor hoes and walking tractors / Accessoires pour motobineuses et motoculteurs .....	102
<b>Rejas para cultivadores</b> Cultivator parts / Grilles pour cultivateur .....	110
<b>Brazos forjados</b> Forged steel tines / Bras forgés .....	122
<b>Dientes - botas de subsolador</b> Teeth - subsoil spare parts / Dent - botte de sous-soleuse .....	126
<b>Accesorios para cultivadores</b> Cultivators accesories / Accessoires pour cultivateurs .....	132
<b>Brazos para cultivadores</b> Tines for cultivators / Bras pour cultivateurs .....	140
<b>Bridas para brazos en espiral</b> Brackets for double coil spring tines / Brides pour bras en spirale .....	144
<b>Brazos chisel</b> Chisel tines / Bras ciseau .....	148
<b>Muelles de compresion</b> Compression springs / Ressorts de compression .....	154
<b>Discos de grada y arado</b> Harrow and plough discs / Herses à disques et charrue .....	158
<b>Tornillería agrícola</b> Agricultural bolts / Visserie agricole .....	168



## INTRODUCCIÓN

La calidad es una constante en Agrícola Navarro desde su fundación en 1969. Se tiene un control integral de todo el proceso, desde la compra de materia prima, hasta la entrega al cliente. Además, al ser Agrícola Navarro una empresa industrial, que fabrica sus propios productos, se utilizan los últimos avances tecnológicos en producción.

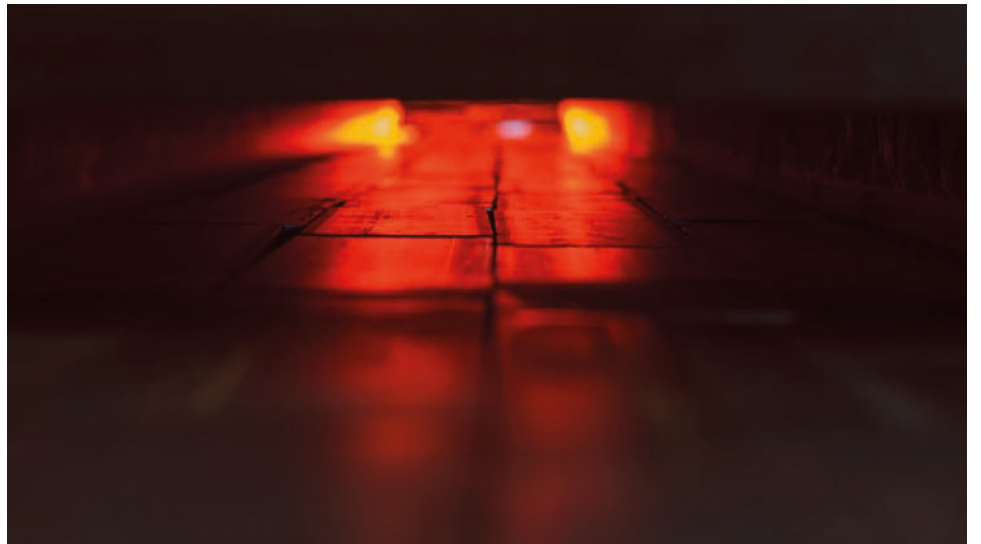

La dilatada experiencia en el sector nos permite tener un alto grado de conocimiento de las necesidades de los clientes e innovar en los productos ofertados.

Y como nuestra responsabilidad va más allá, disponemos de un sistema de gestión de Calidad ISO 9001 certificado para garantizar al cliente el trabajo bien hecho, utilizamos pinturas ecológicas como medida de sostenibilidad ambiental, y en materia de RSC colaboramos con la sociedad que nos rodea a través de diferentes patrocinios y el compromiso con nuestros trabajadores y sus familias.





### ¿POR QUÉ FABRICAMOS LA MEJOR CUCHILLA?

Nuestras cuchillas se caracterizan por su durabilidad, resistencia y acabado. Solo utilizamos como materia prima aceros especiales al boro de primera calidad, adquiridos de proveedores de primer nivel. Para conseguir la adecuada elasticidad y dureza de las piezas, le aplicamos al acero los tratamientos térmicos necesarios. Todo ello nos permite ofrecer un recambio agrícola con máximo rendimiento y muy resistente ante roturas en cualquier tipo de terreno.

Y aunque, lo más importante es que las cuchillas tengan un funcionamiento óptimo en el campo, nos esmeramos en el acabado mediante un proceso de pintura que evita la oxidación de las piezas y le confieren al producto un aspecto inmejorable. Además, para facilitar la identificación, todos nuestros productos van marcados con su referencia mediante estampación.







### NUESTRA EVOLUCION

**BUREAU VERITAS**  
Certification



A lo largo de los años hemos ido creciendo de manera sostenida, consolidando primero el mercado nacional y Portugal, y en los últimos años se ha realizado un gran esfuerzo en la estrategia de internacionalización de la empresa, que nos ha permitido estar presentes en clientes de más de 20 países de Europa, América, Asia y Norte de África.

El servicio nos diferencia de los competidores, al poder gestionar pedidos con plazos de entrega muy cortos, ya que se dispone de un amplio stock de productos, líneas de producción flexibles con gran eficiencia, y gran surtido de matricería.

En materia de sistemas de información, hemos incorporado lo último en programas informáticos de gestión integrado en todos los departamentos de la compañía, lo que nos permite ser muy ágiles en nuestro funcionamiento y automatizar una gran parte de los procesos.

Nuestras oficinas e instalaciones de producción y almacén han ido aumentando en superficie y equipamiento a lo largo de los años, ya que se ha llevado a cabo un proceso de reinversión constante para mantener el nivel de servicio y la capacidad de producción que nuestros clientes se merecen.

La marca AN nos distingue en Calidad y Servicio, y es consecuencia directa de hacer las cosas bien durante muchos años en el sector.





## INTRODUCTION

Since the Foundation of Agrícola Navarro in 1969, the quality has been a constant, as we control all the process, from the raw material to delivery of the product to the customer. Agrícola Navarro is an Industrial company, it means, we manufacture our own products through the latest technological advances.

The extensive experience in the sector allows us to achieve a high knowledge for customers' needs, offering and developing new products for them.

Agrícola Navarro believes that its responsibility goes further, therefore, has obtained a Quality Management System ISO 9001 to guarantee to the customers the best work, using ecological paint as a measure of environmental sustainability, and collaborating in different projects with Social Responsibility, as well as the commitment with its employees and their families.







### **WHY WE MANUFACTURE THE BEST BLADE?**

Our blades are distinguished by its durability, resistance and finished, due to be made of high quality boron steel, from the best suppliers.

To achieve the suitable elasticity and hardness on the pieces we apply to the steel the thermal treatments required. All the above, allow us to offer a high-performance agricola spare part, reducing breaks in any kind of land.

Although the most important is that blades have optimal functioning in the field, we take care of the finish of the product, applying a special paint process to avoid the rusting on the pieces, that gives to the products an excellent appearance.

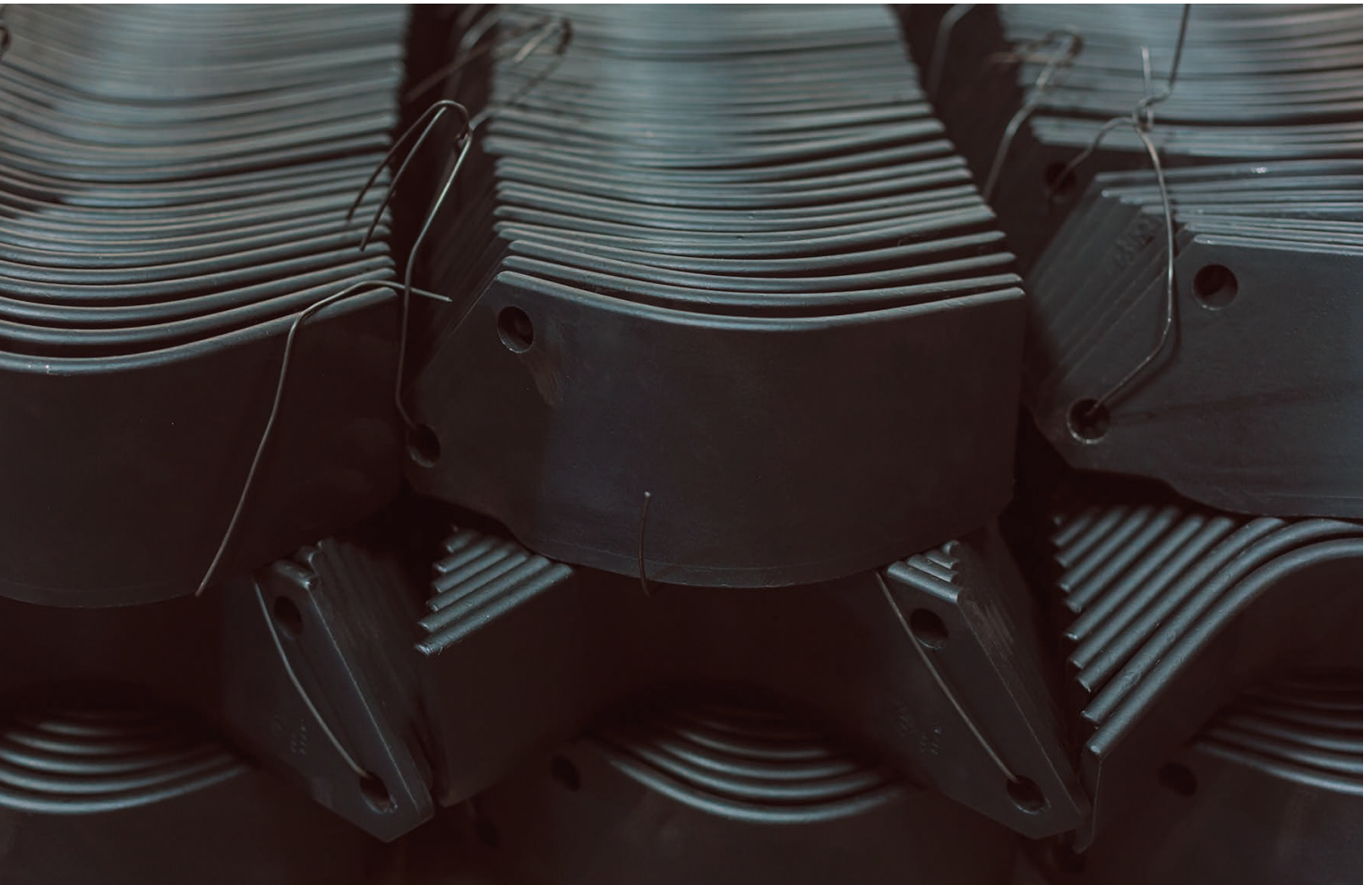

## OUR EVOLUTION

Throughout the years, Agrícola Navarro has been growing sustained and it has been consolidate, firstly in national market and in Portugal and in the recent years, through an effort in international markets, Agrícola Navarro is present in more than 20 countries of Europe, America, Asia and North of Africa.

The service is our main difference from our competitors, we are able to handle orders with short terms of delivery, because we have huge range of stock products, flexible lines of production with great efficacy and great assortment of die-stamping.

About information systems we recently have incorporated the latest software program (integrated management in all departments of the company) that allow us to be agile in our functioning.

The AN brand is distinguishing by Quality and Service, and it is a result of many years doing well the things in our sector.







## INTRODUCTION

Depuis sa création en 1969, la qualité est une constante chez Agrícola Navarro. Nous contrôlons intégralement tout le processus, depuis l'achat des matières premières jusqu'à la livraison au client. En outre, nous fabriquons nos propres produits, Agrícola Navarro est une entreprise industrielle qui utilise les derniers progrès technologiques en matière de production.

Notre vaste expérience dans le secteur permet d'avoir un degré élevé de connaissances des besoins de nos clients, ainsi que d'innover sans cesse les produits que nous proposons.

Etant donné que notre responsabilité va au-delà, nous disposons d'un système de gestion de Qualité ISO 9001 certifié pour garantir à notre clientèle un véritable savoir-faire. Nous utilisons des peintures écologiques comme mesure de protection environnementale, et, en matière de RSC nous collaborons avec une société locale par le biais de différents sponsors ainsi que par l'engagement de nos employés et de leurs familles.



### **POURQUOI FABRIQUONS-NOUS LES MEILLEURES LAMES ?**

Nos lames sont caractérisées par leur durabilité, résistance et finition.

Comme matière première, nous n'utilisons que des aciers spécifiques, avec un bore de première qualité, acquis par des fournisseurs de haut niveau. Pour obtenir l'élasticité adéquate et la dureté de nos pièces, nous appliquons sur l'acier les traitements thermiques nécessaires. Tout cela nous permet d'offrir des pièces de rechanges agricoles avec un rendement maximum et très résistant en cas de ruptures sur n'importe quel type de terrain.

Et même si le plus important reste que les lames aient un fonctionnement optimal dans le champ, nous prenons soin des finitions à travers un processus de peinture qui évite l'oxydation des pièces et confère au produit un aspect exceptionnel. De plus, afin de faciliter leur identification, tous nos produits sont marqués d'une référence unique par un processus d'estampage.

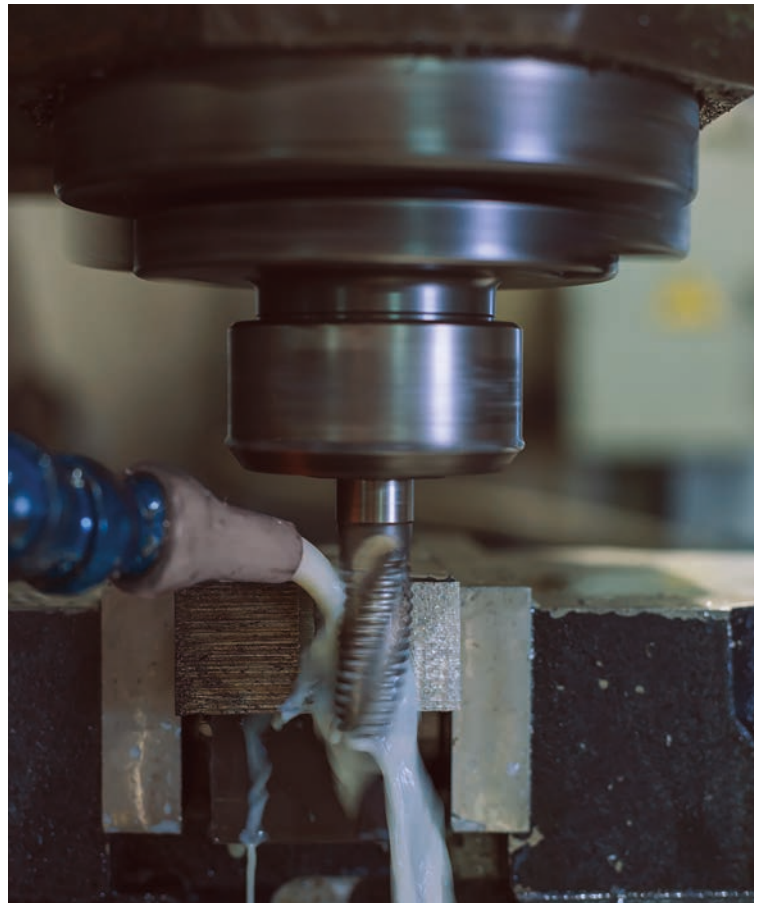





## NOTRE ÉVOLUTION

Au cours des années, Agrícola Navarro a considérablement grandi, consolidant tout d'abord son marché national ainsi que le Portugal, et, depuis les dernières années, nous avons concentré tous nos efforts dans la stratégie d'ouverture de notre entreprise vers l'international, ce qui nous a permis d'être présents pour des clients de plus de 20 pays d'Europe, d'Amérique, d'Asie et d'Afrique du Nord.



Ce qui nous distingue de nos concurrents est la qualité de notre service, nous parvenons en effet à gérer des commandes dont les délais de livraison sont des plus courts. Nous disposons d'un stock très étendu de produits, de lignes de production suffisamment souple avec une et grande efficacité et un important choix de matrices.

En termes de système d'information, les différents départements de la compagnie sont pourvus des plus récents programmes informatiques de gestion intégrée, ce qui nous permet d'être très réactifs dans notre fonctionnement mais aussi d'automatiser une grande partie des processus de production.

Nos bureaux, nos installations de production et notre atelier n'ont cessé d'augmenter en superficie et équipement au fil du temps, l'entreprise a mené à bien un processus de réinvestissement constant afin de maintenir la qualité du service et la capacité de production que nos clients méritent.

La marque Agrícola Navarro nous distingue en Qualité et Service, conséquence directe d'un savoir-faire depuis de nombreuses années dans le secteur.



**AGRÍCOLA  
NAVARRO**

**CATALOGO GENERAL**

**GENERAL CATALOGUE**

**CATALOGUE GENERAL**



# CUCHILLAS

Cutting blades / Lames



AGRATOR		DISEÑO/DESIGN		MEDIDAS / MEASUREMENTS (mm)						
REF.				A	B	W	T	D.C.	HOLE Ø	gf
REF. 2-UNI				180	140	80	7	57	13,5	1.110
AR				MÁQUINA / TILLER MOD.						
REF. 2-UNI				180	140	80	8	57	13,5	1.290
AR				MÁQUINA / TILLER MOD.						
REF. 2-CTF				180	140	80	7	57	13,5	1.110
AL / ALR / GE-2T / VF				MÁQUINA / TILLER MOD.						
REF. 2-CTF				180	140	80	8	57	13,5	1.184
AL / ALR / GE-2T / VF				MÁQUINA / TILLER MOD.						
REF. 2-R				180	140	80	7	57	13,5	1.055
AR				MÁQUINA / TILLER MOD.						
REF. 2-R				180	140	80	8	57	13,5	1.225
AR				MÁQUINA / TILLER MOD.						
REF. 2-R				180	140	80	10	57	11,75	1.484
AR				MÁQUINA / TILLER MOD.						
REF. 10-C/E				175	115	60	6	36	11,75	630
AV				MÁQUINA / TILLER MOD.						
REF. 10-L/E				175	140	60	6	36	9 COLISO	700
AV				MÁQUINA / TILLER MOD.						
REF. 135-E				195	135	80	7	57	13,5	1.075
AR				MÁQUINA / TILLER MOD.						

A = ALTURA B= CRUCE W = ANCHO T = ESPESOR D.C = DISTANCIA ENTRE CENTROS / A = LENGTH B= HEIGHT W= WIDTH T= THICKNESS D.C= DIST. BETWEEN CENTERS

AGRATOR		DISEÑO/DESIGN	MEDIDAS / MEASUREMENTS (mm)						
REF.			A	B	W	T	D.C.	HOLE Ø	gr
REF. 207-E									
VF-AL	MÁQUINA / TILLER MOD.		180	135	75	6	57	11,5	900
REF. 332 1 T									
MÁQUINA / TILLER MOD.			240	43	50	12	0	17	1070
REF. 332 - S/F									
ART	MÁQUINA / TILLER MOD.		238	40	50	12	51	17	1.020
REF. 332 - C/F									
ART	MÁQUINA / TILLER MOD.		238	40	50	12	51	17	1.020
REF. 480									
AM / KD	MÁQUINA / TILLER MOD.		205	145	100	10	75	17	1.875
REF. 607									
MÁQUINA / TILLER MOD.			220	130	100	10	75	17	1.695
REF. 618									
ASR / AM	MÁQUINA / TILLER MOD.		185	145	90	10	57	17	1.450
REF. 679									
GT / GMT / GRT / ALT	MÁQUINA / TILLER MOD.		230	50	50	12	51	17	1.005
REF. 700									
GT / GMT / GRT / ALT	MÁQUINA / TILLER MOD.		190	85	80	10	57	16,5	1.265
REF. 719									
MÁQUINA / TILLER MOD.			175	150	85	9	57	16,5	1.470

A = ALTURA B= CRUCE W = ANCHO T = ESPESOR D.C = DISTANCIA ENTRE CENTROS / A = LENGTH B= HEIGHT W= WIDTH T= THICKNESS D.C= DIST. BETWEEN CENTERS

AGRATOR		DISEÑO/DESIGN		MEDIDAS / MEASUREMENTS (mm)						
REF.				A	B	W	T	D.C.	HOLE Ø	gf
REF. 720										
AV	MÁQUINA / TILLER MOD.			245	105	40	8	114	12	720
REF. M-1										
TRITURADOR										
COLISO	MÁQUINA / TILLER MOD.			106	44	40	8	0	30X14	250
REF. M-14										
TRITURADOR										
NORMAL	MÁQUINA / TILLER MOD.			140	60	60	8	0	26	540
REF. M-15										
TRITURADOR										
NORMAL	MÁQUINA / TILLER MOD.			140	60	60	10	0	26	645
REF. M-18										
TRITURADOR										
NORMAL	MÁQUINA / TILLER MOD.			200	60	60	10	0	26	935
REF. M-19										
TRITURADOR										
NORMAL	MÁQUINA / TILLER MOD.			185	65	60	10	0	26	880
REF. M-29										
NORMAL RECTO	MÁQUINA / TILLER MOD.			200	0	60	10	0	26	850
REF. GANCHO										
G-1										
PARA PATATA	MÁQUINA / TILLER MOD.			340	180	45	10	80	12,5	1.270
REF. GANCHO										
G-2										
PARA PATATA	MÁQUINA / TILLER MOD.			340	170	50	10	100	14,5	1.390

A = ALTURA B = CRUCE W = ANCHO T = ESPESOR D.C = DISTANCIA ENTRE CENTROS / A = LENGTH B = HEIGHT W = WIDTH T = THICKNESS D.C = DIST. BETWEEN CENTERS



AGRIA		DISEÑO/DESIGN	MEDIDAS / MEASUREMENTS (mm)						
REF.	MÁQUINA / TILLER MOD.		A	B	W	T	D.C.	HOLE Ø	g
REF. 25-L			210	65	30	5	65-70	11 COLISO	275
REF. 25-S			195	60	30	5	65-70	9 COLISO	240
REF. 38-E			205	80	35	6	61,5-71	11 COLISO	350
7700	MÁQUINA / TILLER MOD.								
REF. 38-N			205	80	35	6	65-70	11 COLISO	370
7700 GLOBAL	MÁQUINA / TILLER MOD.								
REF. 64-2T			200	110	70	6	42	12,5	720
1900 / 8900 9900 LEVANTE	MÁQUINA / TILLER MOD.								
REF. 64/A-3T			200	110	70	6	36	10,5	825
1900 / 8900 9900	MÁQUINA / TILLER MOD.								
REF. 66 3T			175	95	60	6	30	10,5	610
	MÁQUINA / TILLER MOD.								
REF. 100-A			220	85	40	6	65-70	11 COLISO	455
7000-C	MÁQUINA / TILLER MOD.								
REF. 112-BIS			190	62	30	5	50-58	9 COLISO	236
7500 COLIBRI	MÁQUINA / TILLER MOD.								
REF. 164-BL2			185	110	60	6	42	12,5	615
2700 LEVANTE	MÁQUINA / TILLER MOD.								

A = ALTURA B = CRUCE W = ANCHO T = ESPESOR D.C = DISTANCIA ENTRE CENTROS / A = LENGTH B = HEIGHT W = WIDTH T = THICKNESS D.C = DIST. BETWEEN CENTERS

AGRIA		DISEÑO/DESIGN		MEDIDAS / MEASUREMENTS (mm)						
REF.				A	B	W	T	D.C.	HOLE Ø	gr.
REF. <b>164-BL3</b>										
2700 LEVANTE MÁQUINA / TILLER MOD.				200	100	60	6	28	10,5 3 TAL	630
REF. <b>169-C</b>										
7000M 6623 / 6624 MÁQUINA / TILLER MOD.				120	60	50	6	50	10,5	315
REF. <b>169-L</b>										
3000 / 3001 MÁQUINA / TILLER MOD.				170	65	50	6	50	10,5	415
REF. <b>178-C</b>										
3000 / 3001 MÁQUINA / TILLER MOD.				220	45	40	5	70	9	355
REF. <b>178-SPL</b>										
3000 / 3001 MÁQUINA / TILLER MOD.				220	65	40	5	70	9	355
REF. <b>178-SPLL</b>										
3000 / 3001 MÁQUINA / TILLER MOD.				198	98	40	5	70	9	380
REF. <b>187</b>										
3000 MALAGUEÑA MÁQUINA / TILLER MOD.				215	95	35	6	65-70	11 COLISO	405
REF. <b>191</b>										
MÁQUINA / TILLER MOD.				215	80	35	6	80	10,5	380
REF. <b>195-C</b>										
2100 MÁQUINA / TILLER MOD.				165	50	30	5	65-70	9	176
REF. <b>195-BABY</b>										
2100 MÁQUINA / TILLER MOD.				165	54	30	5	65-70	9	206

AGRIA		DISEÑO/DESIGN	MEDIDAS / MEASUREMENTS (mm)					
<b>REF. 198-CPD</b>		A	B	W	T	D.C.	HOLE Ø	gr
7714 / 7713 MÁQUINA / TILLER MOD.		190	85	60	6	42	12,5	555
<b>REF. 198-CTD</b>		A	B	W	T	D.C.	HOLE Ø	gr
7714 / 7713 MÁQUINA / TILLER MOD.		185	90	60	6	42	12,5	520
<b>REF. 198-E</b>		A	B	W	T	D.C.	HOLE Ø	gr
7714 / 7712 / 7713 MÁQUINA / TILLER MOD.		175	95	60	6	42	12,5	560
<b>REF. 198 ENTERA</b>		A	B	W	T	D.C.	HOLE Ø	gr
7714 / 7713 MÁQUINA / TILLER MOD.		195	95	60	6	42	12,5	665
<b>REF. 200-CM</b>		A	B	W	T	D.C.	HOLE Ø	gr
7000 MÁQUINA / TILLER MOD.		195	75	30	5	45-50	10,5 COLISO	265
<b>REF. 205</b>		A	B	W	T	D.C.	HOLE Ø	gr
7000 MÁQUINA / TILLER MOD.		180	65	30	5	45-50	10,5 COLISO	235
<b>REF. 214-EL</b>		A	B	W	T	D.C.	HOLE Ø	gr
7000 MÁQUINA / TILLER MOD.		230	90	40	6	80	$\frac{10,5}{8,5}$	485
<b>REF. 214-JT</b>		A	B	W	T	D.C.	HOLE Ø	gr
7000 MÁQUINA / TILLER MOD.		220	85	40	6	80	10,5	450
<b>REF. 254</b>		A	B	W	T	D.C.	HOLE Ø	gr
7700 MÁQUINA / TILLER MOD.		145	100	50	6	25	10,5	400
<b>REF. 254-A</b>		A	B	W	T	D.C.	HOLE Ø	gr
7713 MÁQUINA / TILLER MOD.		140	100	50	6	25	10,5	425

A = ALTURA B = CRUCE W = ANCHO T = ESPESOR D.C. = DISTANCIA ENTRE CENTROS / A = LENGTH B = HEIGHT W = WIDTH T = THICKNESS D.C. = DIST. BETWEEN CENTERS

AGRIA		DISEÑO/DESIGN		MEDIDAS / MEASUREMENTS (mm)				
REF. 277		A	B	W	T	D.C.	HOLE Ø	9g
1100 MÁQUINA / TILLER MOD.		180	70	30	5	65-70	9	230
REF. 310		A	B	W	T	D.C.	HOLE Ø	9g
MÁQUINA / TILLER MOD.		180	60	35	6	65-70	11 COLISO	305
REF. 391-A		A	B	W	T	D.C.	HOLE Ø	9g
7708 MÁQUINA / TILLER MOD.		165	60	30	5	50-58	9	215
REF. GANCHO G-4		A	B	W	T	D.C.	HOLE Ø	9g
1900 MÁQUINA / TILLER MOD.		215	160	30	10	65-70	10,5 COLISO	580
REF. GANCHO G-5		A	B	W	T	D.C.	HOLE Ø	9g
3000 MÁQUINA / TILLER MOD.		150	150	30	10	68-72	10,5 COLISO	460
REF. GANCHO G-6		A	B	W	T	D.C.	HOLE Ø	9g
7000 MÁQUINA / TILLER MOD.		200	150	30	10	68-72	10,5	545
AGRIC		DISEÑO/DESIGN		MEDIDAS / MEASUREMENTS (mm)				
REF. 2-UNI		A	B	W	T	D.C.	HOLE Ø	9g
BM /BMS/BMR MÁQUINA / TILLER MOD.		180	140	80	7	57	13,5	1.110
REF. 2-UNI		A	B	W	T	D.C.	HOLE Ø	9g
BM /BMS/BMR MÁQUINA / TILLER MOD.		180	140	80	8	57	13,5	1.290
REF. 2-R		A	B	W	T	D.C.	HOLE Ø	9g
BM /BMS/BMR MÁQUINA / TILLER MOD.		180	140	80	7	57	13,5	1.055
REF. 2-R		A	B	W	T	D.C.	HOLE Ø	9g
BM /BMS/BMR MÁQUINA / TILLER MOD.		180	140	80	8	57	13,5	1.225

A = ALTURA B = CRUCE W = ANCHO T = ESPESOR D.C = DISTANCIA ENTRE CENTROS / A = LENGTH B = HEIGHT W = WIDTH T = THICKNESS D.C = DIST. BETWEEN CENTERS

AGRIC		DISEÑO/DESIGN		MEDIDAS / MEASUREMENTS (mm)						
REF.				A	B	W	T	D.C.	HOLE Ø	gr
REF. 10				145	135	60	6	36	11,75	670
MÁQUINA / TILLER MOD.										
REF. 10-C				165	125	60	$\frac{6}{7}$	36	$\frac{11,75}{12,5}$	$\frac{625}{720}$
AL/AFMJ/ALD MÁQUINA / TILLER MOD.										
REF. 10-L				150	145	60	6	36	11,75	670
AFMJ MÁQUINA / TILLER MOD.										
REF. 135-E				195	135	80	7	57	13,5	1075
BMR MÁQUINA / TILLER MOD.										
REF. 207-E				180	135	75	6	57	11,75	900
AF/AMSE AMS/AFMD MÁQUINA / TILLER MOD.										
REF. 207-R				140	135	75	6	57	11,75	810
AF/AMSE AMS/AFMD MÁQUINA / TILLER MOD.										
REF. 315				230	70	60	10	46	15	1.050
ROTOLABOR MÁQUINA / TILLER MOD.										
REF. 315-1T				237	58	60	10	0	17	1.080
ROTOLABOR MÁQUINA / TILLER MOD.										
REF. 332 S/F				238	40	50	12	51	17	1.020
ROTOCULTIVADOR MÁQUINA / TILLER MOD.										
REF. 332 C/F				238	40	50	12	51	17	1.020
ROTOCULTIVADOR MÁQUINA / TILLER MOD.										

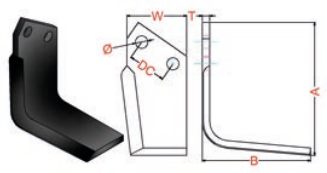
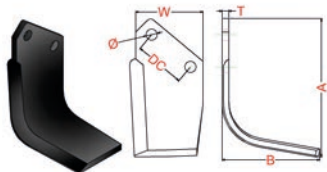
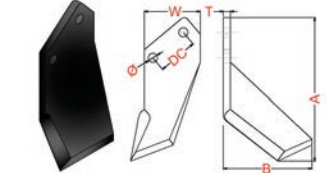
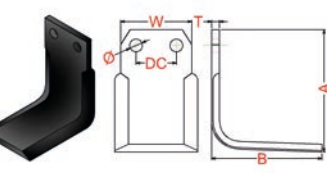
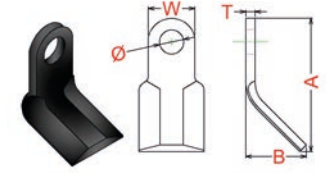
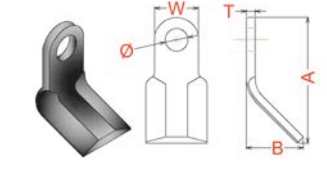
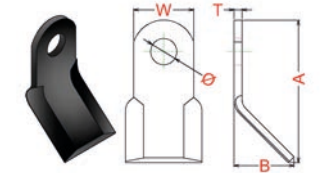
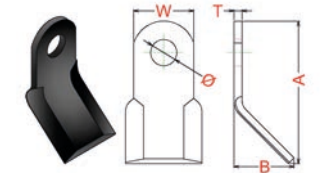
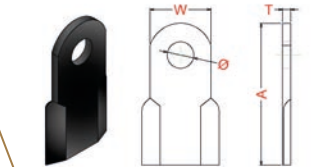
AGRIC		DISEÑO/DESIGN		MEDIDAS / MEASUREMENTS (mm)				
REF. 457		A	B	W	T	D.C.	HOLE Ø	gr
SRF / SRG MÁQUINA / TILLER MOD.		175	145	80	10	51	16,5	1.390
REF. 480		A	B	W	T	D.C.	HOLE Ø	gr
SRG MÁQUINA / TILLER MOD.		205	145	100	10	75	17	1.695
REF. 490		A	B	W	T	D.C.	HOLE Ø	gr
INVERTIDO MÁQUINA / TILLER MOD.		205	127	80	10	57	13,5	1.280
REF. 706		A	B	W	T	D.C.	HOLE Ø	gr
INVERTIDO MÁQUINA / TILLER MOD.		155	140	90	10	51	16,5	1780
REF. M-4/21 TRITURADOR		A	B	W	T	D.C.	HOLE Ø	gr
NORMAL MÁQUINA / TILLER MOD.		114	52	40	8	0	21	295
REF. M-4/21 TRITURADOR		A	B	W	T	D.C.	HOLE Ø	gr
NORMAL MÁQUINA / TILLER MOD.		114	52	40	8	0	21	295
REF. M-14 TRITURADOR		A	B	W	T	D.C.	HOLE Ø	gr
NORMAL MÁQUINA / TILLER MOD.		140	60	60	8	0	26	540
REF. M-15 TRITURADOR		A	B	W	T	D.C.	HOLE Ø	gr
NORMAL MÁQUINA / TILLER MOD.		140	60	60	10	0	26	645
REF. M-30 TRITURADOR		A	B	W	T	D.C.	HOLE Ø	gr
NORMAL/RECTO MÁQUINA / TILLER MOD.		150	0	60	10	0	26	710



AGROVIL		DISEÑO/DESIGN		MEDIDAS / MEASUREMENTS (mm)						
REF.				A	B	W	T	D.C.	HOLE Ø	gr
REF. 207-E				180	135	75	6	57	11,5	900
MÁQUINA / TILLER MOD.										
REF. 207				180	135	75	6	57	12,5	890
MÁQUINA / TILLER MOD.										
REF. 457				175	145	80	10	51	16,5	1390
FC MÁQUINA / TILLER MOD.										
REF. 691				190	140	80	7	57	12,5	1.050
FRC/FR/FRE MÁQUINA / TILLER MOD.										
ALFA		DISEÑO/DESIGN		MEDIDAS / MEASUREMENTS (mm)						
REF.				A	B	W	T	D.C.	HOLE Ø	gr
REF. 38-N				205	80	35	6	65-70	10,5 COLISO	370
MÁQUINA / TILLER MOD.										
REF. 38-A				215	80	40	5	65-70	10,5 COLISO	360
MÁQUINA / TILLER MOD.										
REF. 100-A				220	85	40	6	65-70	11 COLISO	455
MÁQUINA / TILLER MOD.										
REF. 100-N				220	85	35	6	65-70	11 COLISO	400
MÁQUINA / TILLER MOD.										
REF. 178-ML				210	75	40	5	65-70	10,5 COLISO	370
1145 / 1146 MÁQUINA / TILLER MOD.										
REF. 253				255	105	50	6	90	12,5	655
MÁQUINA / TILLER MOD.										

A = ALTURA B = CRUCE W = ANCHO T = ESPESOR D.C. = DISTANCIA ENTRE CENTROS / A = LENGTH B = HEIGHT W = WIDTH T = THICKNESS D.C. = DIST. BETWEEN CENTERS



ALFA		DISEÑO/DESIGN		MEDIDAS / MEASUREMENTS (mm)				
REF. 254		A	B	W	T	D.C.	HOLE Ø	gr
MÁQUINA / TILLER MOD.		145	100	50	6	25	10,5	400
REF. 254-A		A	B	W	T	D.C.	HOLE Ø	gr
MÁQUINA / TILLER MOD.		140	100	50	6	25	10,5	425
ALPEGO		DISEÑO/DESIGN		MEDIDAS / MEASUREMENTS (mm)				
REF. 12		A	B	W	T	D.C.	HOLE Ø	gr
MÁQUINA / TILLER MOD.		330	21	60	10	130	15	1.350
REF. 602		A	B	W	T	D.C.	HOLE Ø	gr
MÁQUINA / TILLER MOD.		210	140	100	10	75	16,5	1.780
REF. 693		A	B	W	T	D.C.	HOLE Ø	gr
MÁQUINA / TILLER MOD.		185	135	80	8	57	14,5	1.130
REF. 694		A	B	W	T	D.C.	HOLE Ø	gr
MÁQUINA / TILLER MOD.		210	140	100	10	75	16,5	1.770
REF. 735		A	B	W	T	D.C.	HOLE Ø	gr
MÁQUINA / TILLER MOD.		360	45	70	10	150	17	1.850
BAIANO		DISEÑO/DESIGN		MEDIDAS / MEASUREMENTS (mm)				
REF. 484-C		A	B	W	T	D.C.	HOLE Ø	gr
Q -85 MÁQUINA / TILLER MOD.		120	124	50	6	40	10,5	390
REF. 484-L		A	B	W	T	D.C.	HOLE Ø	gr
Q -85 MÁQUINA / TILLER MOD.		137	120	50	6	40	10,5	445

A = ALTURA B = CRUCE W = ANCHO T = ESPESOR D.C = DISTANCIA ENTRE CENTROS / A = LENGTH B = HEIGHT W = WIDTH T = THICKNESS D.C = DIST. BETWEEN CENTERS

BARBIERI		DISEÑO/DESIGN		MEDIDAS / MEASUREMENTS (mm)				
REF.		A	B	W	T	D.C.	HOLE Ø	gr
REF. 38-N		205	80	35	6	65-70	10,5 COLISO	370
MÁQUINA / TILLER MOD.								
REF. 266-C		220	80	40	6	70-80	11 COLISO	420
RL C1 CONDOR								
MÁQUINA / TILLER MOD.								
REF. 266-L		230	76	45	6	70-80	11 COLISO	480
RL C3 CONDOR								
MÁQUINA / TILLER MOD.								
REF. 269-C		195	55	35	5	68	9	295
RL A1 AIRONE								
MÁQUINA / TILLER MOD.								
REF. 330		200	80	50	6	80	10,5	450
MCG-10 PIONEER 1200								
MÁQUINA / TILLER MOD.								
REF. 387-TC		194	82	45	5	30-40	11 COLISO	400
MCG -14 S.1400								
MÁQUINA / TILLER MOD.								
REF. 392-M		225	65	45	5	68-72	10,5	410
GAZZELLA								
MÁQUINA / TILLER MOD.								
REF. 404		170	95	60	6	42	10,5	550
MCG /18 PANTERA								
MÁQUINA / TILLER MOD.								
REF. 417		204	55	40	5	68	10,5	310
MÁQUINA / TILLER MOD.								
REF. 434		195	60	40	6	76	10,5	365
MÁQUINA / TILLER MOD.								

A = ALTURA B = CRUCE W = ANCHO T = ESPESOR D.C = DISTANCIA ENTRE CENTROS / A = LENGTH B = HEIGHT W = WIDTH T = THICKNESS D.C = DIST. BETWEEN CENTERS

BARBIERI		DISEÑO/DESIGN	MEDIDAS / MEASUREMENTS (mm)					
REF. 675		A	B	W	T	D.C.	HOLE Ø	gf
FB-1600 MÁQUINA / TILLER MOD.		200	80	40	6	76	10,5	395
B.C.S.		DISEÑO/DESIGN	MEDIDAS / MEASUREMENTS (mm)					
REF. 195-A		A	B	W	T	D.C.	HOLE Ø	gf
GRILLINO MÁQUINA / TILLER MOD.		165	52	30	5	55	9	215
REF. 341		A	B	W	T	D.C.	HOLE Ø	gf
705 MÁQUINA / TILLER MOD.		145	80	50	6	40	10,5	390
REF. 341-A		A	B	W	T	D.C.	HOLE Ø	gf
705 MÁQUINA / TILLER MOD.		155	80	50	6	40	10,5	420
REF. 343-C		A	B	W	T	D.C.	HOLE Ø	gf
735/705 PATERNO MÁQUINA / TILLER MOD.		122	55	40	6	29	10,5	255
REF. 343-L		A	B	W	T	D.C.	HOLE Ø	gf
MÁQUINA / TILLER MOD.		147	55	40	6	27	10,5	280
REF. 343-P		A	B	W	T	D.C.	HOLE Ø	gf
MÁQUINA / TILLER MOD.		140	80	40	6	27	10,5	295
REF. 476		A	B	W	T	D.C.	HOLE Ø	gf
715 GRILLINO B-4 MÁQUINA / TILLER MOD.		190	50	30	5	50-57	9 COLISO	250
REF. 667		A	B	W	T	D.C.	HOLE Ø	gf
MÁQUINA / TILLER MOD.		190	60	30	5	50-57	9 COLISO	250
REF. 667		A	B	W	T	D.C.	HOLE Ø	gf
715 T. AMERICA MÁQUINA / TILLER MOD.		190	70	35	6	50-57	9 COLISO	340

B.C.S.		DISEÑO/DESIGN		MEDIDAS / MEASUREMENTS (mm)				
<b>REF. 670</b>		A	B	W	T	D.C.	HOLE Ø	gfr
CAR-03 MÁQUINA / TILLER MOD.		170	80	35	6	50-57	9 COLISO	330
<b>REF. 704</b>		A	B	W	T	D.C.	HOLE Ø	gfr
MÁQUINA / TILLER MOD.		193	60	35	6	56	9 COLISO	350
<b>BECCHIO</b>		<b>DISEÑO/DESIGN</b>						
<b>REF. M-1</b> <b>TRITURADOR</b>		A	B	W	T	D.C.	HOLE Ø	gfr
COLISO MÁQUINA / TILLER MOD.		106	44	40	8	0	30X14	250
<b>REF. M-13</b> <b>TRITURADOR</b>		A	B	W	T	D.C.	HOLE Ø	gfr
NORMAL RECTO MÁQUINA / TILLER MOD.		140	FILO 66	60	8	0	26	475
<b>REF. M-14</b> <b>TRITURADOR</b>		A	B	W	T	D.C.	HOLE Ø	gfr
NORMAL MÁQUINA / TILLER MOD.		140	60	60	8	0	26	540
<b>REF. M-15</b> <b>TRITURADOR</b>		A	B	W	T	D.C.	HOLE Ø	gfr
NORMAL MÁQUINA / TILLER MOD.		140	60	60	10	0	26	645
<b>REF. M-28</b> <b>TRITURADOR</b>		A	B	W	T	D.C.	HOLE Ø	gfr
COLISO MÁQUINA / TILLER MOD.		95	40	40	8	0	30X14	225
<b>REF. M-31</b> <b>TRITURADOR</b>		A	B	W	T	D.C.	HOLE Ø	gfr
COLISO RECTO MÁQUINA / TILLER MOD.		105	0	40	8	0	30X14	200
<b>BELAFER</b>		<b>DISEÑO/DESIGN</b>						
<b>REF. 2-UNI</b>		A	B	W	T	D.C.	HOLE Ø	gfr
FR MÁQUINA / TILLER MOD.		180	140	80	7	57	13,5	1.110











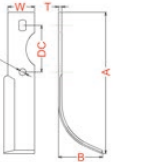

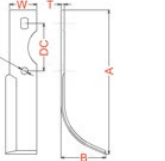

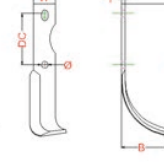

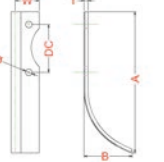

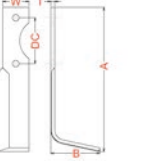
BELAFER		DISEÑO/DESIGN		MEDIDAS / MEASUREMENTS (mm)				
REF. <b>11</b>		A	B	W	T	D.C.	HOLE Ø	gr
FL MÁQUINA / TILLER MOD.		160	120	60	6	35	11,75	580
REF. <b>11</b>		A	B	W	T	D.C.	HOLE Ø	gr
FL MÁQUINA / TILLER MOD.		160	120	60	6	35	13	615
REF. <b>135-E</b>		A	B	W	T	D.C.	HOLE Ø	gr
FR MÁQUINA / TILLER MOD.		195	135	80	7	57	13,5	1.075
REF. <b>M-1</b>		A	B	W	T	D.C.	HOLE Ø	gr
TRITURADOR COLISO MÁQUINA / TILLER MOD.		106	44	40	8	0	30X14	250
REF. <b>M-14</b>		A	B	W	T	D.C.	HOLE Ø	gr
TRITURADOR NORMAL MÁQUINA / TILLER MOD.		140	60	60	8	0	26	540
REF. <b>M-21</b>		A	B	W	T	D.C.	HOLE Ø	gr
TRITURADOR NORMAL MÁQUINA / TILLER MOD.		148	40	60	8	0	28	515
BENASSI		DISEÑO/DESIGN		MEDIDAS / MEASUREMENTS (mm)				
REF. <b>25-S</b>		A	B	W	T	D.C.	HOLE Ø	gr
MÁQUINA / TILLER MOD.		195	60	30	5	65-70	9 COLISO	240
REF. <b>38-E</b>		A	B	W	T	D.C.	HOLE Ø	gr
AL-75/3/9 MÁQUINA / TILLER MOD.		205	80	35	6	61,5-71	11 COLISO	350
REF. <b>38-N</b>		A	B	W	T	D.C.	HOLE Ø	gr
S-308 MÁQUINA / TILLER MOD.		205	80	35	6	65-70	11 COLISO	370
REF. <b>100-A</b>		A	B	W	T	D.C.	HOLE Ø	gr
MÁQUINA / TILLER MOD.		220	85	40	6	65-70	11 COLISO	455

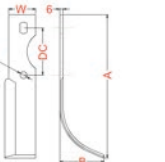
BENASSI		DISEÑO/DESIGN		MEDIDAS / MEASUREMENTS (mm)				
REF. <b>100-N</b>		A	B	W	T	D.C.	HOLE $\emptyset$	
MÁQUINA / TILLER MOD.		220	85	35	6	65-70	11 COLISO	400
REF. <b>178-B</b>		A	B	W	T	D.C.	HOLE $\emptyset$	
BL-90 MÁQUINA / TILLER MOD.		215	70	40	5	70	9 COLISO	330
REF. <b>178-B</b>		A	B	W	T	D.C.	HOLE $\emptyset$	
BL-90 MÁQUINA / TILLER MOD.		215	70	40	5	70	10,5	350
REF. <b>178-ML</b>		A	B	W	T	D.C.	HOLE $\emptyset$	
MÁQUINA / TILLER MOD.		210	75	40	5	65-70	10,5 COLISO	370
REF. <b>195-BABY</b>		A	B	W	T	D.C.	HOLE $\emptyset$	
MÁQUINA / TILLER MOD.		165	54	30	5	65-70	9 COLISO	206
REF. <b>269-C</b>		A	B	W	T	D.C.	HOLE $\emptyset$	
RL-40 MÁQUINA / TILLER MOD.		195	55	35	5	68	9 COLISO	295
REF. <b>280</b>		A	B	W	T	D.C.	HOLE $\emptyset$	
SI300 Z3-BL 75 MÁQUINA / TILLER MOD.		205	64	45	5	67-73	8,5 COLISO	365
REF. <b>324-C</b>		A	B	W	T	D.C.	HOLE $\emptyset$	
RL-95 MÁQUINA / TILLER MOD.		235	90	50	6	80	11	590
REF. <b>349</b>		A	B	W	T	D.C.	HOLE $\emptyset$	
Z3 MÁQUINA / TILLER MOD.		200	75	45	6	68-72	10,5 COLISO	460
BERTOLINI		DISEÑO/DESIGN		MEDIDAS / MEASUREMENTS (mm)				
REF. <b>253</b>		A	B	W	T	D.C.	HOLE $\emptyset$	
S-310 MÁQUINA / TILLER MOD.		255	105	50	6	90	13,5	655

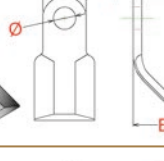
BERTOLINI		DISEÑO/DESIGN	MEDIDAS / MEASUREMENTS (mm)					
REF. <b>254-A</b>		A	B	W	T	D.C.	HOLE Ø	9g
S-315 MÁQUINA / TILLER MOD.		140	100	50	6	25	10,5	425
REF. <b>460</b>		A	B	W	T	D.C.	HOLE Ø	9g
MÁQUINA / TILLER MOD.		160	55	50	6	29	10,5	390
REF. <b>464</b>		A	B	W	T	D.C.	HOLE Ø	9g
S-318 MÁQUINA / TILLER MOD.		140	90	50	6	29	10,5	410
REF. <b>476</b>		A	B	W	T	D.C.	HOLE Ø	9g
S-306 MÁQUINA / TILLER MOD.		190	50	30	5	50-57	9 COLISO	250
REF. <b>493</b>		A	B	W	T	D.C.	HOLE Ø	9g
MÁQUINA / TILLER MOD.		170	85	50	6	46	13	520
REF. <b>656</b>		A	B	W	T	D.C.	HOLE Ø	9g
MÁQUINA / TILLER MOD.		165	60	30	5	50-58	9 COLISO	180
REF. <b>667</b>		A	B	W	T	D.C.	HOLE Ø	9g
25 MÁQUINA / TILLER MOD.		190	70	35	6	50-58	9 COLISO	340
REF. <b>667</b>		A	B	W	T	D.C.	HOLE Ø	9g
MÁQUINA / TILLER MOD.		190	70	30	5	50-58	9 COLISO	255
BONANZA		DISEÑO/DESIGN	MEDIDAS / MEASUREMENTS (mm)					
REF. <b>207-B</b>		A	B	W	T	D.C.	HOLE Ø	9g
MÁQUINA / TILLER MOD.		180	135	75	6	57	13,5	885
REF. <b>M-14</b> TRITURADOR		A	B	W	T	D.C.	HOLE Ø	9g
NORMAL MÁQUINA / TILLER MOD.		140	60	60	8	0	26	540

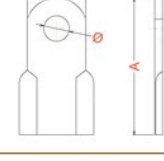

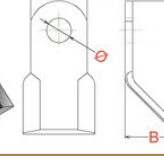

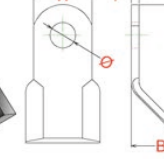







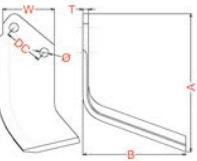

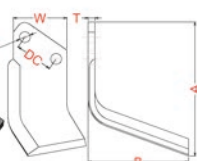

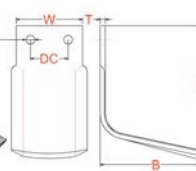

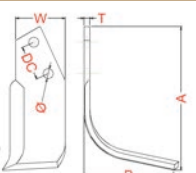

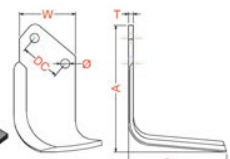
BONANZA		DISEÑO/DESIGN		MEDIDAS / MEASUREMENTS (mm)				
REF. <b>M-15</b> TRITURADOR		A	B	W	T	D.C.	HOLE Ø	gfr
NORMAL MÁQUINA / TILLER MOD.		140	60	60	10	0	26	645
BREVIGLIERI		DISEÑO/DESIGN		MEDIDAS / MEASUREMENTS (mm)				
REF. <b>2-R</b>		A	B	W	T	D.C.	HOLE Ø	gfr
MÁQUINA / TILLER MOD.		180	140	80	8	57	13,5	1.484
REF. <b>2-UNI</b>		A	B	W	T	D.C.	HOLE Ø	gfr
MÁQUINA / TILLER MOD.		180	140	80	7	57	14,5	1.160
REF. <b>2-UNI</b>		A	B	W	T	D.C.	HOLE Ø	gfr
MÁQUINA / TILLER MOD.		180	140	80	8	57	14,5	1.280
REF. <b>135-E</b>		A	B	W	T	D.C.	HOLE Ø	gfr
B2/B12 BV2-20302 MÁQUINA / TILLER MOD.		195	135	80	7	57	13,5	1.075
REF. <b>485</b>		A	B	W	T	D.C.	HOLE Ø	gfr
BR15/B25 B12-20322 MÁQUINA / TILLER MOD.		195	135	80	8	57	15	1.225
BRUMITAL		DISEÑO/DESIGN		MEDIDAS / MEASUREMENTS (mm)				
REF. <b>38-N</b>		A	B	W	T	D.C.	HOLE Ø	gfr
MÁQUINA / TILLER MOD.		205	80	35	6	65-70	11 COLISO	370
REF. <b>100</b>		A	B	W	T	D.C.	HOLE Ø	gfr
RECORD MÁQUINA / TILLER MOD.		220	85	45	6	65-70	11 COLISO	510
REF. <b>100-A</b>		A	B	W	T	D.C.	HOLE Ø	gfr
DS-10 MÁQUINA / TILLER MOD.		220	85	40	6	65-70	11 COLISO	435

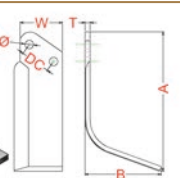

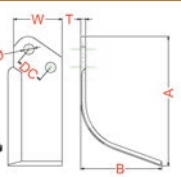

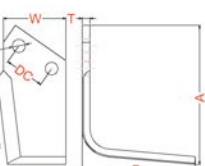

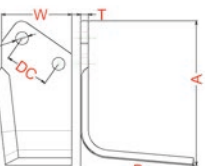

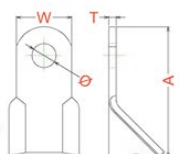

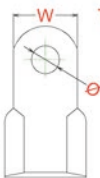

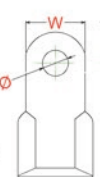





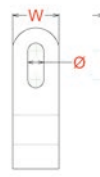



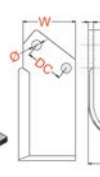

BRUMITAL		DISEÑO/DESIGN	MEDIDAS / MEASUREMENTS (mm)						
REF. <b>100-N</b>			A	B	W	T	D.C.	HOLE Ø	gr
DS-10 MÁQUINA / TILLER MOD.			220	85	35	6	65-70	11 COLISO	400
REF. <b>100-SA</b>			A	B	W	T	D.C.	HOLE Ø	gr
MÁQUINA / TILLER MOD.			220	85	50	6	65-70	10,5 COLISO	560
REF. <b>178-ML</b>			A	B	W	T	D.C.	HOLE Ø	gr
DS-12 RECORD MÁQUINA / TILLER MOD.			210	75	40	5	65-70	10,5 COLISO	370
REF. <b>335</b>			A	B	W	T	D.C.	HOLE Ø	gr
KLEIN MÁQUINA / TILLER MOD.			175	60	30	5	60	8,5	210
REF. <b>452</b>			A	B	W	T	D.C.	HOLE Ø	gr
DS-10 MÁQUINA / TILLER MOD.			220	75	40	6	70	11 COLISO	475
REF. <b>472</b>			A	B	W	T	D.C.	HOLE Ø	gr
MÁQUINA / TILLER MOD.			186	80	35	5	65-73,5	9	290
CANCELLA		DISEÑO/DESIGN	MEDIDAS / MEASUREMENTS (mm)						
REF. <b>M-4/21</b> TRITURADOR			A	B	W	T	D.C.	HOLE Ø	gr
NORMAL MÁQUINA / TILLER MOD.			114	52	40	8	0	21	295
REF. <b>M-13</b> TRITURADOR			A	B	W	T	D.C.	HOLE Ø	gr
RECTO MÁQUINA / TILLER MOD.			140	0	60	8	0	26	475
REF. <b>M-14</b> TRITURADOR			A	B	W	T	D.C.	HOLE Ø	gr
NORMAL MÁQUINA / TILLER MOD.			140	60	60	8	0	26	540
REF. <b>M-15</b> TRITURADOR			A	B	W	T	D.C.	HOLE Ø	gr
NORMAL MÁQUINA / TILLER MOD.			140	60	60	10	0	26	645

<b>CANTARELO</b>		<b>DISEÑO/DESIGN</b>	<b>MEDIDAS / MEASUREMENTS (mm)</b>					
<b>REF. 2-CANT</b>		A	B	W	T	D.C.	HOLE Ø	gr
MÁQUINA / TILLER MOD.		180	120	80	7	57	13,5	1040
<b>REF. 8</b>		A	B	W	T	D.C.	HOLE Ø	gr
MÁQUINA / TILLER MOD.		155	120	60	7	44	13,5	710
<b>REF. 102</b>		A	B	W	T	D.C.	HOLE Ø	gr
MÁQUINA / TILLER MOD.		225	110	60	7	0	13,5	900
<b>CARRARO</b>		<b>DISEÑO/DESIGN</b>	<b>MEDIDAS / MEASUREMENTS (mm)</b>					
<b>REF. 467</b>		A	B	W	T	D.C.	HOLE Ø	gr
TIGRE MÁQUINA / TILLER MOD.		190	115	70	6	53-57	13 COLISO	720
<b>REF. 493</b>		A	B	W	T	D.C.	HOLE Ø	gr
CARRARINO MÁQUINA / TILLER MOD.		170	85	50	6	46	13	520
<b>REF. 670</b>		A	B	W	T	D.C.	HOLE Ø	gr
CAR 03 MÁQUINA / TILLER MOD.		170	80	35	6	50-57	9	330
<b>REF. 704</b>		A	B	W	T	D.C.	HOLE Ø	gr
CARRARINO MINI HP 5-8 MÁQUINA / TILLER MOD.		193	60	35	6	56	9	350
<b>CASORZO</b>		<b>DISEÑO/DESIGN</b>	<b>MEDIDAS / MEASUREMENTS (mm)</b>					
<b>REF. 25-S</b>		A	B	W	T	D.C.	HOLE Ø	gr
MÁQUINA / TILLER MOD.		195	60	30	5	65-70	9 COLISO	240
<b>REF. 345</b>		A	B	W	T	D.C.	HOLE Ø	gr
MÁQUINA / TILLER MOD.		195	70	45	6	72	8,5	480

CAVABE		DISEÑO/DESIGN		MEDIDAS / MEASUREMENTS (mm)				
REF. <b>64-2T</b>		A	B	W	T	D.C.	HOLE Ø	9g
MÁQUINA / TILLER MOD.		200	110	70	6	42	12,5	720
REF. <b>M-14 TRITURADOR</b>		A	B	W	T	D.C.	HOLE Ø	9g
NORMAL MÁQUINA / TILLER MOD.		140	60	60	8	0	26	540
<b>CELLI</b>		<b>DISEÑO/DESIGN</b>						
REF. <b>429</b>		A	B	W	T	D.C.	HOLE Ø	9g
AG MÁQUINA / TILLER MOD.		168	110	60	6	40	13	565
REF. <b>433</b>		A	B	W	T	D.C.	HOLE Ø	9g
E/F/HV/HF MÁQUINA / TILLER MOD.		180	140	80	7	57	14,5	1.125
REF. <b>442</b>		A	B	W	T	D.C.	HOLE Ø	9g
CE MÁQUINA / TILLER MOD.		175	135	70	6	50	15	815
REF. <b>456</b>		A	B	W	T	D.C.	HOLE Ø	9g
MÁQUINA / TILLER MOD.		195	105	80	7	57	15	1.000
REF. <b>470</b>		A	B	W	T	D.C.	HOLE Ø	9g
E/F/HV/HF MÁQUINA / TILLER MOD.		200	130	80	7	57	15	1.095
REF. <b>485</b>		A	B	W	T	D.C.	HOLE Ø	9g
MÁQUINA / TILLER MOD.		190	138	80	$\frac{8}{10}$	57	16	1.225
REF. <b>616</b>		A	B	W	T	D.C.	HOLE Ø	9g
MÁQUINA / TILLER MOD.		190	140	80	9	57	15	1.406
REF. <b>636</b>		A	B	W	T	D.C.	HOLE Ø	9g
MÁQUINA / TILLER MOD.		183	140	80	10	57	16,5	1.512

CELLI		DISEÑO/DESIGN		MEDIDAS / MEASUREMENTS (mm)				
REF. <b>641</b>		A	B	W	T	D.C.	HOLE Ø	gr
MÁQUINA / TILLER MOD.		190	148	80	$\frac{9}{10}$	57	15	1.346
REF. <b>687</b>		A	B	W	T	D.C.	HOLE Ø	gr
G HP 100 OLTRE MÁQUINA / TILLER MOD.		210	140	80	10	57	14,5	1.580
REF. <b>687</b>		A	B	W	T	D.C.	HOLE Ø	gr
G HP 100 OLTRE MÁQUINA / TILLER MOD.		210	140	80	10	57	16,5	1.620
REF. <b>698</b>		A	B	W	T	D.C.	HOLE Ø	gr
FRANGOR MÁQUINA / TILLER MOD.		235	45	50	12	45	17	1.065
REF. <b>M-52</b>		A	B	W	T	D.C.	HOLE Ø	gr
MÁQUINA / TILLER MOD.		200	53	60	10	0	26	934
CONDOR		DISEÑO/DESIGN						
REF. <b>178-CD</b>		A	B	W	T	D.C.	HOLE Ø	gr
MOTOAZADA MÁQUINA / TILLER MOD.		210	70	40	5	65-75	9 COLISO	360
ENGUIX		DISEÑO/DESIGN						
REF. <b>2-UNI</b>		A	B	W	T	D.C.	HOLE Ø	gr
VM MÁQUINA / TILLER MOD.		180	140	80	$\frac{7}{8}$	57	13,5	$\frac{1.110}{1.290}$
REF. <b>2-CTF</b>		A	B	W	T	D.C.	HOLE Ø	gr
PSR MÁQUINA / TILLER MOD.		180	140	80	7	57	13,5	$\frac{1.110}{1.290}$
REF. <b>107</b>		A	B	W	T	D.C.	HOLE Ø	gr
AN/VLM /VM MÁQUINA / TILLER MOD.		200	150	75	9	57	13,5	1.390

ENGUIX		DISEÑO/DESIGN		MEDIDAS / MEASUREMENTS (mm)						
REF.				A	B	W	T	D.C.	HOLE Ø	gr.
REF. 107				200	150	80	7	57	13,5	1.175
AN/VLM /VM	MÁQUINA / TILLER MOD.									
REF. 107 L-7				195	150	80	10	57	17	1.168
	MÁQUINA / TILLER MOD.									
REF. 107 R DOBLE FILO				200	150	100	8	57	13,5 16,5	1.550 1.515
	MÁQUINA / TILLER MOD.									
REF. 131-E				170	115	60	7	42	13	690
	MÁQUINA / TILLER MOD.									
REF. 135-E				195	135	80	7	57	13,5	1.075
DM / VM	MÁQUINA / TILLER MOD.									
REF. 172-C				160	90	50	6	35	10,5	470
	MÁQUINA / TILLER MOD.									
REF. 172-M				165	100	60	6	35	13	560
T	MÁQUINA / TILLER MOD.									
REF. 457				175	145	80	7/8	51	16,5	1.390
	MÁQUINA / TILLER MOD.									
REF. 618				185	145	90	10	57	16,5	1450
PSR / SRC	MÁQUINA / TILLER MOD.									
REF. M-14 TRITURADOR				140	60	60	8	0	26	540
NORMAL	MÁQUINA / TILLER MOD.									

ENGUIX		DISEÑO/DESIGN		MEDIDAS / MEASUREMENTS (mm)						
REF. <b>M-15</b> TRITURADOR				A	B	W	T	D.C.	HOLE Ø	gfr
NORMAL MÁQUINA / TILLER MOD.				140	60	60	10	0	26	645
REF. <b>M-17</b> TRITURADOR				A	B	W	T	D.C.	HOLE Ø	gfr
NORMAL MÁQUINA / TILLER MOD.				145	98	60	10	0	26	840
<b>EPOKE</b>		<b>DISEÑO/DESIGN</b>								
REF. <b>M-36</b>				A	B	W	T	D.C.	HOLE Ø	gfr
MÁQUINA / TILLER MOD.				99	43	40	$\frac{7}{8}$	0	34x17	330
REF. <b>M-41</b>				A	B	W	T	D.C.	HOLE Ø	gfr
				124	34	40	10	0	39x14,5	340
<b>FALC</b>		<b>DISEÑO/DESIGN</b>								
REF. <b>315</b>				A	B	W	T	D.C.	HOLE Ø	gfr
TERRAKING MÁQUINA / TILLER MOD.				230	70	60	10	46	15	1.050
REF. <b>470</b>				A	B	W	T	D.C.	HOLE Ø	gfr
INTERFILARE MÁQUINA / TILLER MOD.				200	130	80	7	57	15	1.095
REF. <b>480</b>				A	B	W	T	D.C.	HOLE Ø	gfr
MÁQUINA / TILLER MOD.				205	145	100	10	75	17	1.695
REF. <b>646</b>				A	B	W	T	D.C.	HOLE Ø	gfr
MÁQUINA / TILLER MOD.				210	145	80	8	56	14,5	1.380
REF. <b>676</b>				A	B	W	T	D.C.	HOLE Ø	gfr
MÁQUINA / TILLER MOD.				205	135	105	8	75	17	1.550







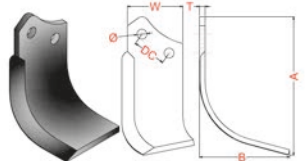
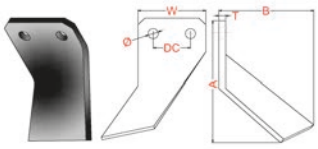
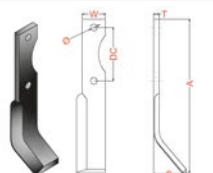
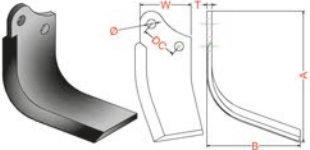
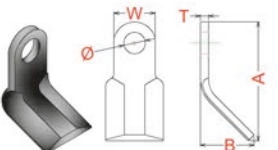

FALC		DISEÑO/DESIGN	MEDIDAS / MEASUREMENTS (mm)					
REF. <b>DIENTE CUADRADO</b>		A	B	W	T	D.C.	HOLE $\emptyset$	gf
ROKING MÁQUINA / TILLER MOD.		180	0	30	30	0	10,5	1.100
REF. <b>M-15 TRITURADOR</b>		A	B	W	T	D.C.	HOLE $\emptyset$	gf
ALCE MÁQUINA / TILLER MOD.		140	60	60	10	0	26	645
REF. <b>M-13</b>		A	B	W	T	D.C.	HOLE $\emptyset$	gf
ALFE RECTO MÁQUINA / TILLER MOD.		140	0	60	8	0	26	645
<b>FERRARI</b>		DISEÑO/DESIGN	MEDIDAS / MEASUREMENTS (mm)					
REF. <b>100-A</b>		A	B	W	T	D.C.	HOLE $\emptyset$	gf
34 MÁQUINA / TILLER MOD.		220	85	40	6	65-70	11 COLISO	455
REF. <b>254</b>		A	B	W	T	D.C.	HOLE $\emptyset$	gf
92/91 MÁQUINA / TILLER MOD.		145	100	50	6	25	10,5	400
REF. <b>254-A</b>		A	B	W	T	D.C.	HOLE $\emptyset$	gf
92/91 MÁQUINA / TILLER MOD.		140	100	50	6	25	10,5	425
REF. <b>506</b>		A	B	W	T	D.C.	HOLE $\emptyset$	gf
MÁQUINA / TILLER MOD.		130	65	45	5	25	10,5	260
REF. <b>651</b>		A	B	W	T	D.C.	HOLE $\emptyset$	gf
MÁQUINA / TILLER MOD.		145	115	50	6	28	10,5	440
<b>FERRI</b>		DISEÑO/DESIGN	MEDIDAS / MEASUREMENTS (mm)					
REF. <b>M-1 TRITURADOR</b>		A	B	W	T	D.C.	HOLE $\emptyset$	gf
COLISO TIPO LARGO MÁQUINA / TILLER MOD.		106	44	40	8	0	30X14	250

A = ALTURA B = CRUCE W = ANCHO T = ESPESOR D.C. = DISTANCIA ENTRE CENTROS / A = LENGTH B = HEIGHT W = WIDTH T = THICKNESS D.C. = DIST. BETWEEN CENTERS

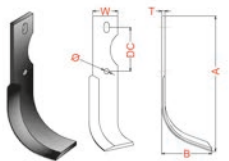
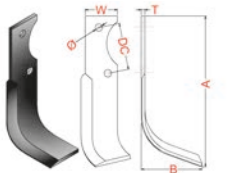
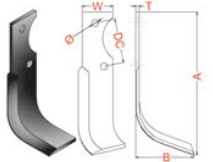
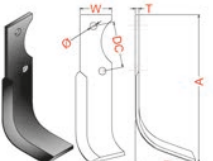
FERRI		DISEÑO/DESIGN		MEDIDAS / MEASUREMENTS (mm)							
REF.	TRITURADOR				A	B	W	T	D.C.	HOLE Ø	gr
REF. <b>M-2</b>	<b>TRITURADOR</b>				80	40	40	8	0	30X14	210
COLISO TIPO CORTO MÁQUINA / TILLER MOD.											
REF. <b>M-4/17</b>	<b>TRITURADOR</b>				114	52	40	8	0	17	300
MÁQUINA / TILLER MOD.											
REF. <b>M-4/21</b>	<b>TRITURADOR</b>				114	52	40	8	0	21	295
MÁQUINA / TILLER MOD.											
REF. <b>M-14</b>	<b>TRITURADOR</b>				140	60	60	8	0	26	540
NORMAL MÁQUINA / TILLER MOD.											
REF. <b>M-15</b>	<b>TRITURADOR</b>				140	60	60	10	0	26	645
NORMAL MÁQUINA / TILLER MOD.											
REF. <b>M-28</b>	<b>TRITURADOR</b>				95	40	40	8	0	34X17	220
COLISO MÁQUINA / TILLER MOD.											
REF. <b>M-31</b>	<b>TRITURADOR</b>				105	0	40	8	0	30X14	200
COLISO RECTO MÁQUINA / TILLER MOD.											
FORIGO		DISEÑO/DESIGN		MEDIDAS / MEASUREMENTS (mm)							
REF.	TRITURADOR				A	B	W	T	D.C.	HOLE Ø	gr
REF. <b>605</b>	<b>TRITURADOR</b>				170	135	90	8	48	15	1.160
G-35 MÁQUINA / TILLER MOD.											
REF. <b>617</b>	<b>TRITURADOR</b>				300	67	50	10	105-115	15	1.076
MÁQUINA / TILLER MOD.											
REF. <b>646</b>	<b>TRITURADOR</b>				210	145	80	8	56	14,5	1.380
MÁQUINA / TILLER MOD.											

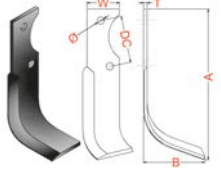
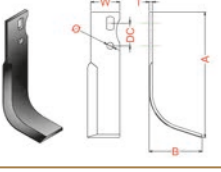
A = ALTURA B= CRUCE W = ANCHO T = ESPESOR D.C = DISTANCIA ENTRE CENTROS / A = LENGTH B= HEIGHT W= WIDTH T= THICKNESS D.C= DIST. BETWEEN CENTERS

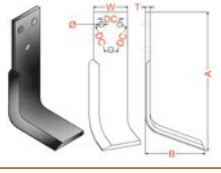
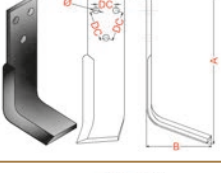
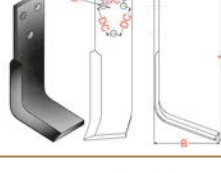
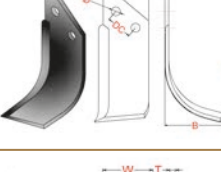
FORIGO		DISEÑO/DESIGN		MEDIDAS / MEASUREMENTS (mm)				
REF. 680		A	B	W	T	D.C.	HOLE Ø	gr
MÁQUINA / TILLER MOD.		200	130	80	8	48	14,5	1.140
REF. 681		A	B	W	T	D.C.	HOLE Ø	gr
G - 45 MÁQUINA / TILLER MOD.		185	135	100	$\frac{8}{10}$	$\frac{56}{51}$	$\frac{15}{16,5}$	$\frac{1.350}{1.670}$
REF. 690		A	B	W	T	D.C.	HOLE Ø	gr
MÁQUINA / TILLER MOD.		330	70	50	12	105-115	15 COLISO	1.415
REF. 818		A	B	W	T	D.C.	HOLE Ø	gr
MÁQUINA / TILLER MOD.		215	142	80	8	56	14,5	1.340
REF. M-4/21 TRITURADOR		A	B	W	T	D.C.	HOLE Ø	gr
MÁQUINA / TILLER MOD.		114	52	40	8	0	21	295
FORT		DISEÑO/DESIGN		MEDIDAS / MEASUREMENTS (mm)				
REF. 100-A		A	B	W	T	D.C.	HOLE Ø	gr
MÁQUINA / TILLER MOD.		220	85	40	6	65-70	11 COLISO	455
REF. 178-CD		A	B	W	T	D.C.	HOLE Ø	gr
MINI TRIGOTTO MÁQUINA / TILLER MOD.		210	70	40	5	65-75	9 COLISO	360
REF. 252-L		A	B	W	T	D.C.	HOLE Ø	gr
TRIGOTTO FT 4 UNIVERSAL MÁQUINA / TILLER MOD.		217	80	45	5	65	10,5	400
REF. 321-C		A	B	W	T	D.C.	HOLE Ø	gr
TRIGOTTO FT 4 UNIVERSAL MÁQUINA / TILLER MOD.		210	65	45	6	65	10,5	446
REF. 321-L		A	B	W	T	D.C.	HOLE Ø	gr
TRIGOTTO FT 4 UNIVERSAL MÁQUINA / TILLER MOD.		220	93	45	6	65	10,5	515

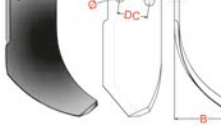





<b>FORT</b>		<b>DISEÑO/DESIGN</b>	<b>MEDIDAS / MEASUREMENTS (mm)</b>					
<b>REF. 325</b>		A	B	W	T	D.C.	HOLE Ø	g
LEONE MÁQUINA / TILLER MOD.		225	90	45	6	75	10,5	500
<b>REF. 387-TC</b>		A	B	W	T	D.C.	HOLE Ø	g
CENTAURO MÁQUINA / TILLER MOD.		194	82	45	5	30-40	11 COLISO	400
<b>REF. 404</b>		A	B	W	T	D.C.	HOLE Ø	g
F - 700 MÁQUINA / TILLER MOD.		170	95	60	6	42	10,5	550
<b>GALUCHO</b>		<b>DISEÑO/DESIGN</b>	<b>MEDIDAS / MEASUREMENTS (mm)</b>					
<b>REF. 398 - A</b>		A	B	W	T	D.C.	HOLE Ø	g
FN/FL-O/FL-OH MÁQUINA / TILLER MOD.		245	105	60	8	33-48/48	10,5 3 TAL	1.085
<b>REF. 398 - C</b>		A	B	W	T	D.C.	HOLE Ø	g
FN/FL-O/FL-OH MÁQUINA / TILLER MOD.		222	97	60	8	33-48/48	10,5 3 TAL	970
<b>REF. 398 - R</b>		A	B	W	T	D.C.	HOLE Ø	g
FN/FL-O/FL-OH MÁQUINA / TILLER MOD.		248	107	60	8	33-48/48	10,5 3 TAL	1.045
<b>REF. 432</b>		A	B	W	T	D.C.	HOLE Ø	g
FL/FRO MÁQUINA / TILLER MOD.		220	107	80	7	45	15	1.075
<b>REF. 488</b>		A	B	W	T	D.C.	HOLE Ø	g
MÁQUINA / TILLER MOD.		185	110	70	8	45	15	1.005
<b>REF. 658</b>		A	B	W	T	D.C.	HOLE Ø	g
MÁQUINA / TILLER MOD.		180	120	60	6	44	12,5	610
<b>REF. 665</b>		A	B	W	T	D.C.	HOLE Ø	g
MÁQUINA / TILLER MOD.		200	90	80	7	45	15	900

GOLDONI		DISEÑO/DESIGN	MEDIDAS / MEASUREMENTS (mm)					
REF. <b>38-N</b>		A	B	W	T	D.C.	HOLE Ø	gr.
MÁQUINA / TILLER MOD.		205	80	35	6	65-70	11 COLISO	370
REF. <b>169-L</b>		A	B	W	T	D.C.	HOLE Ø	gr.
FRESA-21 MÁQUINA / TILLER MOD.		170	65	50	6	50	10,5	415
REF. <b>234</b>		A	B	W	T	D.C.	HOLE Ø	gr.
EXPOR -518 MÁQUINA / TILLER MOD.		265	95	60	6	100	12,5	755
REF. <b>330</b>		A	B	W	T	D.C.	HOLE Ø	gr.
FRESA-21 MÁQUINA / TILLER MOD.		200	80	50	6	80	10,5	450
REF. <b>387-TC</b>		A	B	W	T	D.C.	HOLE Ø	gr.
FRESA-22 MÁQUINA / TILLER MOD.		194	82	45	5	30-40	11 COLISO	400
REF. <b>404</b>		A	B	W	T	D.C.	HOLE Ø	gr.
FRESA-22 MOD.NUEVO 43124265 MÁQUINA / TILLER MOD.		170	95	60	6	42	10,5	550
REF. <b>466</b>		A	B	W	T	D.C.	HOLE Ø	gr.
FRESA-50 MOD.719/9 417-8 MÁQUINA / TILLER MOD.		195	95	60	6	40-44	13 COLISO	590
REF. <b>467</b>		A	B	W	T	D.C.	HOLE Ø	gr.
FRESA - 40 MÁQUINA / TILLER MOD.		190	115	70	6	51-57	13 COLISO	715
REF. <b>627</b>		A	B	W	T	D.C.	HOLE Ø	gr.
MÁQUINA / TILLER MOD.		190	85	45	6	41	10,5	465
REF. <b>660</b>		A	B	W	T	D.C.	HOLE Ø	gr.
MÁQUINA / TILLER MOD.		165	85	50	6	41	10,5	440

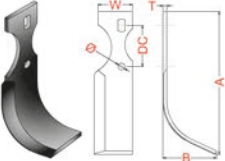
A = ALTURA B = CRUCE W = ANCHO T = ESPESOR D.C = DISTANCIA ENTRE CENTROS / A = LENGTH B = HEIGHT W = WIDTH T = THICKNESS D.C = DIST. BETWEEN CENTERS

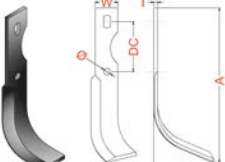
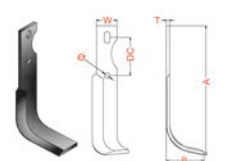
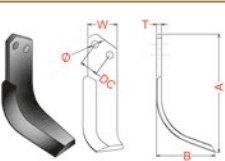
GRILLO		DISEÑO/DESIGN		MEDIDAS / MEASUREMENTS (mm)						
REF.				A	B	W	T	D.C.	HOLE Ø	gf.
REF. 25-S										
G -63	MÁQUINA / TILLER MOD.			195	60	30	5	65-70	9 COLISO	240
REF. 38-E										
GN-10	MÁQUINA / TILLER MOD.			205	80	35	6	61,5-71	11 COLISO	350
REF. 100-A										
MÁQUINA / TILLER MOD.				220	85	40	6	65-70	11 COLISO	455
REF. 100-N										
MÁQUINA / TILLER MOD.				220	85	35	6	65-70	11 COLISO	400
REF. 112-BIS										
SUPER MINI GRILLO	MÁQUINA / TILLER MOD.			190	62	30	5	50-58	9 COLISO	236
REF. 195-C										
MÁQUINA / TILLER MOD.				165	50	30	5	65-70	9 COLISO	176
REF. 341										
131	MÁQUINA / TILLER MOD.			145	80	50	6	40	10,5	390
REF. 341-A										
131	MÁQUINA / TILLER MOD.			155	80	50	6	40	10,5	420
REF. 353										
G -127	MÁQUINA / TILLER MOD.			185	80	50	6	62-70	11 COLISO	430
REF. 391-A										
B-4	MÁQUINA / TILLER MOD.			165	60	30	5	50-58	9 COLISO	215

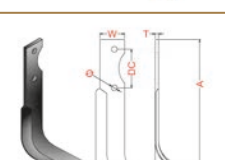
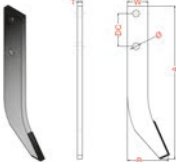
A = ALTURA B= CRUCE W = ANCHO T = ESPESOR D.C = DISTANCIA ENTRE CENTROS / A = LENGTH B= HEIGHT W= WIDTH T= THICKNESS D.C= DIST. BETWEEN CENTERS

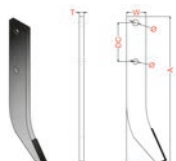
GRILLO		DISEÑO/DESIGN		MEDIDAS / MEASUREMENTS (mm)				
<b>REF. 391-E</b>		A	B	W	T	D.C.	HOLE Ø	gr.
B - 4 MÁQUINA / TILLER MOD.		187	75	45	5	50-58	9 COLISO	340
<b>REF. 394</b>		A	B	W	T	D.C.	HOLE Ø	gr.
40003 MÁQUINA / TILLER MOD.		187	60	35	5	63-70	9 COLISO	275
<b>REF. 394-A</b>		A	B	W	T	D.C.	HOLE Ø	gr.
40003 MÁQUINA / TILLER MOD.		205	73	30	5	63-70	9 COLISO	240
<b>REF. 476</b>		A	B	W	T	D.C.	HOLE Ø	gr.
B - 4 MÁQUINA / TILLER MOD.		190	50	30	5	50-57	9 COLISO	250
<b>REF. 614</b>		A	B	W	T	D.C.	HOLE Ø	gr.
MÁQUINA / TILLER MOD.		140	70	35	6	22	9	245
<b>REF. 671-C</b>		A	B	W	T	D.C.	HOLE Ø	gr.
11000 MÁQUINA / TILLER MOD.		212	80	40	6	68-73	10,5 COLISO	420
<b>REF. 704</b>		A	B	W	T	D.C.	HOLE Ø	gr.
B - 4 MÁQUINA / TILLER MOD.		193	60	35	6	56	9	350
<b>GRIMME</b>		DISEÑO/DESIGN		MEDIDAS / MEASUREMENTS (mm)				
<b>REF. PUA 7</b>		A	B	W	T	D.C.	HOLE Ø	gr.
MÁQUINA / TILLER MOD.		375	100	50	12	80	17	1.615
<b>REF. PUA 9</b>		A	B	W	T	D.C.	HOLE Ø	gr.
MÁQUINA / TILLER MOD.		380	100	50	12	100	14	1.670
<b>REF. PUA 10</b>		A	B	W	T	D.C.	HOLE Ø	gr.
MÁQUINA / TILLER MOD.		385	100	50	12	100	14,5 16,5	1.585



GRIMME		DISEÑO/DESIGN		MEDIDAS / MEASUREMENTS (mm)				
REF. <b>PUA 14</b>		A	B	W	T	D.C.	HOLE Ø	gr
MÁQUINA / TILLER MOD.		370	130	50	12	80	14,5	1.680
REF. <b>PUA 15</b>		A	B	W	T	D.C.	HOLE Ø	gr
MÁQUINA / TILLER MOD.		265	105	45	12	46	17	940
REF. <b>PUA 16</b>		A	B	W	T	D.C.	HOLE Ø	gr
MÁQUINA / TILLER MOD.		282	120	45	12	46	17	1.165
REF. <b>PUA 17</b>		A	B	W	T	D.C.	HOLE Ø	gr
MÁQUINA / TILLER MOD.		275	112	50	12	80	$\frac{12}{16}$	1.135
REF. <b>2-R</b>		A	B	W	T	D.C.	HOLE Ø	gr
STCK MÁQUINA / TILLER MOD.		180	140	80	$\frac{7}{8}$	57	15	$\frac{1.045}{1.225}$
REF. <b>8</b>		A	B	W	T	D.C.	HOLE Ø	gr
STC MÁQUINA / TILLER MOD.		155	120	60	7	44	13,5	710
REF. <b>412</b>		A	B	W	T	D.C.	HOLE Ø	gr
LR / L MÁQUINA / TILLER MOD.		180	100	60	6	44	13,5	570
REF. <b>456</b>		A	B	W	T	D.C.	HOLE Ø	gr
MÁQUINA / TILLER MOD.		195	105	80	7	57	15	1.000
REF. <b>471</b>		A	B	W	T	D.C.	HOLE Ø	gr
TC / STCK MÁQUINA / TILLER MOD.		185	130	80	7	57	15	975
REF. <b>486</b>		A	B	W	T	D.C.	HOLE Ø	gr
MÁQUINA / TILLER MOD.		175	100	60	7	44	13	640

A = ALTURA B= CRUCE W = ANCHO T = ESPESOR D.C = DISTANCIA ENTRE CENTROS / A = LENGTH B= HEIGHT W= WIDTH T= THICKNESS D.C= DIST. BETWEEN CENTERS

HERCULANO		DISEÑO/DESIGN		MEDIDAS / MEASUREMENTS (mm)				
REF. 509		A	B	W	T	D.C.	HOLE Ø	gr.
MÁQUINA / TILLER MOD.		170	110	60	7	44	13	725
REF. 692		A	B	W	T	D.C.	HOLE Ø	gr.
MÁQUINA / TILLER MOD.		190	110	60	7	45	14,5	720
REF. 708		A	B	W	T	D.C.	HOLE Ø	gr.
MÁQUINA / TILLER MOD.		195	105	60	7	45	15	720
HERSI		DISEÑO/DESIGN		MEDIDAS / MEASUREMENTS (mm)				
REF. 129-L		A	B	W	T	D.C.	HOLE Ø	gr.
MÁQUINA / TILLER MOD.		195	90	35	6	48-50	11	315
REF. 178-MLTC		A	B	W	T	D.C.	HOLE Ø	gr.
MÁQUINA / TILLER MOD.		210	75	40	5	68-72	11	370
REF. 200-CM		A	B	W	T	D.C.	HOLE Ø	gr.
MÁQUINA / TILLER MOD.		195	75	30	5	45-50	10,5 COLISO	265
REF. 205		A	B	W	T	D.C.	HOLE Ø	gr.
MÁQUINA / TILLER MOD.		180	65	30	5	45-50	10,5 COLISO	235
HONDA		DISEÑO/DESIGN		MEDIDAS / MEASUREMENTS (mm)				
REF. 299		A	B	W	T	D.C.	HOLE Ø	gr.
410 STANDAR MÁQUINA / TILLER MOD.		210	80	35	5	90	9	345
REF. 300		A	B	W	T	D.C.	HOLE Ø	gr.
400 STANDAR MÁQUINA / TILLER MOD.		210	60	35	5	90	9	315
REF. 335		A	B	W	T	D.C.	HOLE Ø	gr.
F-210 MÁQUINA / TILLER MOD.		175	60	30	5	60	8,5	210

HONDA		DISEÑO/DESIGN	MEDIDAS / MEASUREMENTS (mm)						
REF.			A	B	W	T	D.C.	HOLE Ø	gr.
<b>REF. 336-CM</b>									
310/340 360/380 MÁQUINA / TILLER MOD.			195	75	35	5	70	8,5	295
<b>REF. 340</b>									
410/420 510/560 MÁQUINA / TILLER MOD.			230	80	35	5	80	10,5	350
<b>REF. 340-TC</b>									
410/420 510/560 MÁQUINA / TILLER MOD.			230	80	35	5	80	9	355
<b>REF. 355</b>									
660/610 MÁQUINA / TILLER MOD.			245	80	35	5	80	10,5	380
<b>REF. 368-C</b>									
SCARDAR MÁQUINA / TILLER MOD.			170	60	30	5	40	8,5	240
<b>REF. 368-L</b>									
SCARDAR MÁQUINA / TILLER MOD.			190	70	30	5	40-70	8,5 3 TAL	265
<b>REF. 397</b>									
F-810 MÁQUINA / TILLER MOD.			230	85	40	5	90	10,5	410
<b>REF. 405-R</b>									
MÁQUINA / TILLER MOD.			185	60	40	5	65-73	8,5 COLISO	305
<b>REF. 431</b>									
MÁQUINA / TILLER MOD.			235	65	40	5	90	10,5	370
<b>REF. 453</b>									
MÁQUINA / TILLER MOD.			155	60	30	5	40-70	9 3 TAL	210

A = ALTURA B= CRUCE W= ANCHO T= ESPESOR D.C= DISTANCIA ENTRE CENTROS / A = LENGTH B= HEIGHT W= WIDTH T= THICKNESS D.C= DIST. BETWEEN CENTERS

HONDA		DISEÑO/DESIGN	MEDIDAS / MEASUREMENTS (mm)					
REF. <b>461</b>		A	B	W	T	D.C.	HOLE Ø	gfr
MÁQUINA / TILLER MOD.		210	60	35	5	90	8,5	305
REF. <b>481</b>		A	B	W	T	D.C.	HOLE Ø	gfr
MÁQUINA / TILLER MOD.		200	55	35	5	70	8,5	305
REF. <b>482-C</b>		A	B	W	T	D.C.	HOLE Ø	gfr
MÁQUINA / TILLER MOD.		200	50	20	8	0	11	490
REF. <b>482-L</b>		A	B	W	T	D.C.	HOLE Ø	gfr
MÁQUINA / TILLER MOD.		220	50	25	10	0	11	595
HOWARD		DISEÑO/DESIGN	MEDIDAS / MEASUREMENTS (mm)					
REF. <b>2-R</b>		A	B	W	T	D.C.	HOLE Ø	gfr
E/CR/HI 3900 /01 MÁQUINA / TILLER MOD.		180	140	80	7	57	13,5	1.055
REF. <b>2-R</b>		A	B	W	T	D.C.	HOLE Ø	gfr
E/CR/HI 3900/01 MÁQUINA / TILLER MOD.		180	140	80	8	57	13,5	1.225
REF. <b>2-R</b> REFORZADA		A	B	W	T	D.C.	HOLE Ø	gfr
E/CR/HI 3900 /01 MÁQUINA / TILLER MOD.		180	140	80	10	57	13,5	1.484
REF. <b>2-UNI</b>		A	B	W	T	D.C.	HOLE Ø	gfr
MÁQUINA / TILLER MOD.		180	140	80	7	57	13,5	1.110
REF. <b>10-H</b>		A	B	W	T	D.C.	HOLE Ø	gfr
H-20/H-25 MÁQUINA / TILLER MOD.		140	140	60	6	35	11,75	585
REF. <b>135-E</b>		A	B	W	T	D.C.	HOLE Ø	gfr
E/CR/HI MÁQUINA / TILLER MOD.		195	135	80	7	57	13,5	1.075

HOWARD		DISEÑO/DESIGN	MEDIDAS / MEASUREMENTS (mm)						
REF.			A	B	W	T	D.C.	HOLE Ø	gf.
REF. 135-E			195	135	80	7	57	11	1.085
MÁQUINA / TILLER MOD.									
REF. 198-H			160	135	60	6	42	12,5	620
H -25 ANTIGUA MÁQUINA / TILLER MOD.									
REF. 207-E			180	135	75	6	57	11,5	900
MÁQUINA / TILLER MOD.									
REF. 207-REC			162	135	75	6	57	11,75	810
HR/P 9900/01 MÁQUINA / TILLER MOD.									
REF. 332 S/F			238	40	50	12	51	17	1.020
ROTOLABOR MÁQUINA / TILLER MOD.									
REF. 445			145	75	60	6	42	12,5	450
H -25 ANTIGUA MÁQUINA / TILLER MOD.									
REF. 457			175	145	80	10	51	16,5	1.390
S/M/AH HR-40 9862/63 MÁQUINA / TILLER MOD.									
REF. 600			200	145	105	8	75	16,5	1.595
6784/6785 MÁQUINA / TILLER MOD.									
REF. 601			180	140	80	7	57	11,75	836
4400/4401 MÁQUINA / TILLER MOD.									
REF. 602			180	140	80	9	51	16,5	1.340
9862/9863 REF.457 MÁQUINA / TILLER MOD.									

A = ALTURA B= CRUCE W = ANCHO T = ESPESOR D.C = DISTANCIA ENTRE CENTROS / A = LENGTH B= HEIGHT W= WIDTH T= THICKNESS D.C= DIST. BETWEEN CENTERS

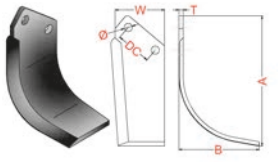
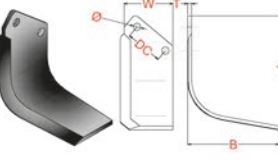
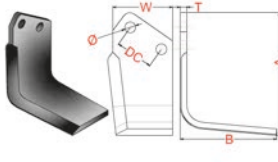
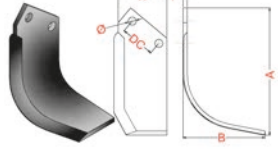
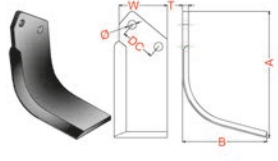
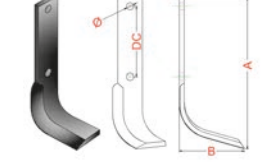
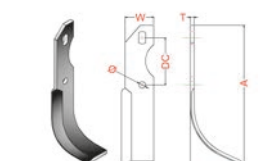
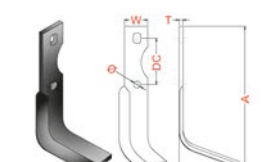
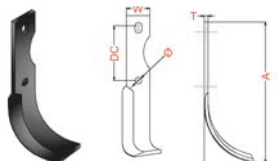
HOWARD		DISEÑO/DESIGN		MEDIDAS / MEASUREMENTS (mm)				
REF.		A	B	W	T	D.C.	HOLE Ø	gr.
REF. 603		A	B	W	T	D.C.	HOLE Ø	gr.
9948/9949	MÁQUINA / TILLER MOD.	210	130	80	7	57	13,5	1.012
REF. 604		A	B	W	T	D.C.	HOLE Ø	gr.
9953/9954	REF 1486	175	140	75	6	57	11,5	775
	MÁQUINA / TILLER MOD.							
REF. 618		A	B	W	T	D.C.	HOLE Ø	gr.
	MÁQUINA / TILLER MOD.	185	145	90	10	57	16,5	1.450
REF. 669		A	B	W	T	D.C.	HOLE Ø	gr.
9948/9949	MÁQUINA / TILLER MOD.	210	135	80	$\frac{7}{10}$	$\frac{51}{57}$	$\frac{13,5}{16,5}$	$\frac{1.510}{1.525}$
REF. 687		A	B	W	T	D.C.	HOLE Ø	gr.
	MÁQUINA / TILLER MOD.	210	140	80	10	57	$\frac{14,5}{16,5}$	$\frac{1.620}{1.580}$
REF. 720		A	B	W	T	D.C.	HOLE Ø	gr.
ROTOCADET	MÁQUINA / TILLER MOD.	245	105	40	8	114	11,75	720
REF. 38-E		A	B	W	T	D.C.	HOLE Ø	gr.
	MÁQUINA / TILLER MOD.	205	80	35	6	65-70	11 COLISO	350
REF. 187		A	B	W	T	D.C.	HOLE Ø	gr.
MALAGUEÑA	MÁQUINA / TILLER MOD.	215	95	35	6	65-70	11 COLISO	450
REF. 310		A	B	W	T	D.C.	HOLE Ø	gr.
	MÁQUINA / TILLER MOD.	180	60	35	6	65-70	11 COLISO	305

ISEKI		DISEÑO/DESIGN		MEDIDAS / MEASUREMENTS (mm)				
REF. <b>178-ML</b>		A	B	W	T	D.C.	HOLE $\emptyset$	
MÁQUINA / TILLER MOD.		210	75	40	5	65-70	10,5	370
REF. <b>336-CM</b>		A	B	W	T	D.C.	HOLE $\emptyset$	
MÁQUINA / TILLER MOD.		195	75	35	5	70	8,5	295
REF. <b>340</b>		A	B	W	T	D.C.	HOLE $\emptyset$	
MÁQUINA / TILLER MOD.		230	80	35	5	80	10,5	350
REF. <b>340-TC</b>		A	B	W	T	D.C.	HOLE $\emptyset$	
MÁQUINA / TILLER MOD.		230	80	35	5	70	8,5	355
REF. <b>355</b>		A	B	W	T	D.C.	HOLE $\emptyset$	
MÁQUINA / TILLER MOD.		245	80	35	5	80	10,5	380
REF. <b>397</b>		A	B	W	T	D.C.	HOLE $\emptyset$	
MÁQUINA / TILLER MOD.		230	85	40	5	90	10,5	410
<b>JOPER</b>		<b>DISEÑO/DESIGN</b>						
REF. <b>315-P</b>		A	B	W	T	D.C.	HOLE $\emptyset$	
MÁQUINA / TILLER MOD.		230	75	60	10	46	15	1.040
REF. <b>430-C</b>		A	B	W	T	D.C.	HOLE $\emptyset$	
JF1/7238-A MÁQUINA / TILLER MOD.		190	125	70	6	57	13,5	735
REF. <b>446</b>		A	B	W	T	D.C.	HOLE $\emptyset$	
JF-0/JF-R/ JF-0D/7032 MÁQUINA / TILLER MOD.		170	106	60	6	46	12,5	545
REF. <b>470</b>		A	B	W	T	D.C.	HOLE $\emptyset$	
JF-2R/22034 MÁQUINA / TILLER MOD.		200	130	80	7	57	14,5	1.095

A = ALTURA B= CRUCE W = ANCHO T = ESPESOR D.C = DISTANCIA ENTRE CENTROS / A = LENGTH B= HEIGHT W= WIDTH T= THICKNESS D.C= DIST. BETWEEN CENTERS



JOPER		DISEÑO/DESIGN		MEDIDAS / MEASUREMENTS (mm)				
REF. 516		A	B	W	T	D.C.	HOLE Ø	9R
MÁQUINA / TILLER MOD.		220	140	80	8	57	15	1.325
REF. 663		A	B	W	T	D.C.	HOLE Ø	9R
RFZR/ 260 MÁQUINA / TILLER MOD.		224	55	60	10	35	12,5	975
KUBOTA		DISEÑO/DESIGN		MEDIDAS / MEASUREMENTS (mm)				
REF. 14		A	B	W	T	D.C.	HOLE Ø	9R
MÁQUINA / TILLER MOD.		193	76	50	8	—	10,5	530
REF. 214-EL		A	B	W	T	D.C.	HOLE Ø	9R
MÁQUINA / TILLER MOD.		230	90	40	6	80	10,5	485
REF. 336-CM		A	B	W	T	D.C.	HOLE Ø	9R
MÁQUINA / TILLER MOD.		195	75	35	5	70	8,5	295
REF. 340		A	B	W	T	D.C.	HOLE Ø	9R
MÁQUINA / TILLER MOD.		230	80	35	5	80	10,5	350
REF. 340-TC		A	B	W	T	D.C.	HOLE Ø	9R
MÁQUINA / TILLER MOD.		230	80	35	5	70	8,5	355
REF. 355		A	B	W	T	D.C.	HOLE Ø	9R
MÁQUINA / TILLER MOD.		245	80	35	5	70	10,5	380
REF. 458		A	B	W	T	D.C.	HOLE Ø	9R
MÁQUINA / TILLER MOD.		175	55	35	5	62-70	11 COLISO	245
REF. 482-C		A	B	W	T	D.C.	HOLE Ø	9R
MÁQUINA / TILLER MOD.		200	50	20	8	0	11	490

KUBOTA		DISEÑO/DESIGN	MEDIDAS / MEASUREMENTS (mm)					
REF. <b>482-L</b>		A	B	W	T	D.C.	HOLE Ø	gr.
MÁQUINA / TILLER MOD.		220	50	25	10	0	11	595
REF. <b>489-L</b>		A	B	W	T	D.C.	HOLE Ø	gr.
MÁQUINA / TILLER MOD.		195	80	35	5	70	8,5	310
KUHN		DISEÑO/DESIGN	MEDIDAS / MEASUREMENTS (mm)					
REF. <b>2-R</b>		A	B	W	T	D.C.	HOLE Ø	gr.
MÁQUINA / TILLER MOD.		180	140	80	7	57	13,5	1.055
REF. <b>457</b>		A	B	W	T	D.C.	HOLE Ø	gr.
MÁQUINA / TILLER MOD.		175	145	80	10	51	16,5	1.390
REF. <b>480</b>		A	B	W	T	D.C.	HOLE Ø	gr.
MÁQUINA / TILLER MOD.		205	145	100	10	75	17	1.875
REF. <b>677</b>		A	B	W	T	D.C.	HOLE Ø	gr.
MÁQUINA / TILLER MOD.		215	45	50	12	50	16,5	960
REF. <b>693</b>		A	B	W	T	D.C.	HOLE Ø	gr.
519370 519371 MÁQUINA / TILLER MOD.		185	135	80	8	57	14,5	1.130
REF. <b>711</b>		A	B	W	T	D.C.	HOLE Ø	gr.
K160109 K160110 MÁQUINA / TILLER MOD.		190	135	90	8	57	16,5	1.225
REF. <b>712</b>		A	B	W	T	D.C.	HOLE Ø	gr.
52348 52349 MÁQUINA / TILLER MOD.		165	135	90	8	57	16,5	1.270
REF. <b>713</b>		A	B	W	T	D.C.	HOLE Ø	gr.
523591 523590 MÁQUINA / TILLER MOD.		200	140	105	8	75	16,5	1.615

KVERNELAND		DISEÑO/DESIGN		MEDIDAS / MEASUREMENTS (mm)				
REF. <b>2-UNI</b>		A	B	W	T	D.C.	HOLE Ø	gr
MÁQUINA / TILLER MOD.		180	140	80	7	57	14,5	1.110
REF. <b>485</b>		A	B	W	T	D.C.	HOLE Ø	gr
MÁQUINA / TILLER MOD.		190	138	80	7	57	15	1.275
REF. <b>488</b>		A	B	W	T	D.C.	HOLE Ø	gr
MÁQUINA / TILLER MOD.		185	110	70	8	45	15	1.040
REF. <b>504</b>		A	B	W	T	D.C.	HOLE Ø	gr
B MÁQUINA / TILLER MOD.		190	120	80	8	46	15	1.100
REF. <b>504</b>		A	B	W	T	D.C.	HOLE Ø	gr
B MÁQUINA / TILLER MOD.		190	120	80	10	46	15	1.425
REF. <b>619</b>		A	B	W	T	D.C.	HOLE Ø	gr
PL MÁQUINA / TILLER MOD.		185	110	60	7	40	15	715
REF. <b>696</b>		A	B	W	T	D.C.	HOLE Ø	gr
MÁQUINA / TILLER MOD.		180	75	80	$\frac{8}{10}$	45	15	$\frac{865}{1.105}$
REF. <b>708</b>		A	B	W	T	D.C.	HOLE Ø	gr
MÁQUINA / TILLER MOD.		195	105	60	7	45	15	720
<b>LAMPACRESCIA2</b>		<b>DISEÑO/DESIGN</b>						
REF. <b>25-S</b>		A	B	W	T	D.C.	HOLE Ø	gr
CASTORO MÁQUINA / TILLER MOD.		195	60	30	5	65-70	9 COLISO	240
REF. <b>38-N</b>		A	B	W	T	D.C.	HOLE Ø	gr
MÁQUINA / TILLER MOD.		205	80	35	6	65-70	11 COLISO	370

**LAMPACRESCIA 2 DISEÑO/DESIGN MEDIDAS / MEASUREMENTS (mm)**

REF. **353**

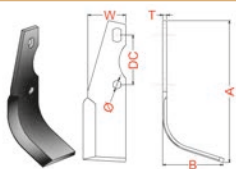

A B W T D.C. HOLE Ø gr.

DL - 10  
MÁQUINA / TILLER MOD.

185 80 50 6 65-70 11 COLISO 425

REF. **704**



A B W T D.C. HOLE Ø gr.

COMBI  
MÁQUINA / TILLER MOD.

193 60 35 6 56 9 350

**LANDER DISEÑO/DESIGN**

REF. **25-S**

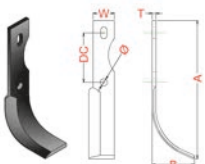

A B W T D.C. HOLE Ø gr.

CU-126  
MÁQUINA / TILLER MOD.

195 60 30 5 65-70 9 COLISO 240

REF. **109**

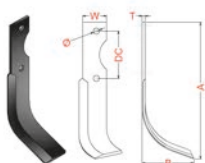

A B W T D.C. HOLE Ø gr.

S-30  
MÁQUINA / TILLER MOD.

240 100 45 7 100 11 695

REF. **109-L**

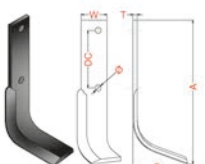

A B W T D.C. HOLE Ø gr.

MÁQUINA / TILLER MOD.

245 100 45 7 100 12,5 700

REF. **178 CD**  
LANDER

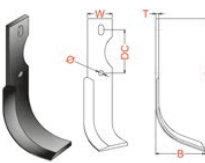

A B W T D.C. HOLE Ø gr.

MOTOAZADA  
MÁQUINA / TILLER MOD.

210 70 40 5 65-70 9 COLISO 360

REF. **198-E**

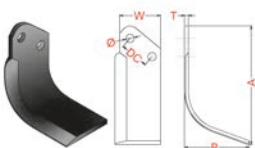

A B W T D.C. HOLE Ø gr.

S-45  
MÁQUINA / TILLER MOD.

175 95 60 6 42 12,5 560

REF. **234**

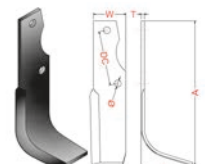

A B W T D.C. HOLE Ø gr.

S-40  
MÁQUINA / TILLER MOD.

265 95 60 6 100 12,5 750

REF. **252-L**

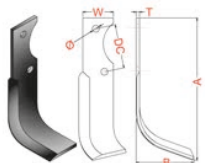

A B W T D.C. HOLE Ø gr.

C-95/S-20  
MÁQUINA / TILLER MOD.

217 80 45 5 65 10,5 400

REF. **302**

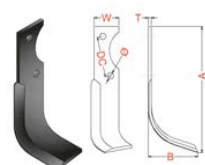









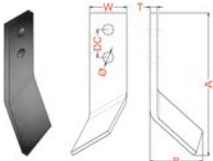
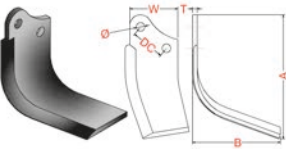
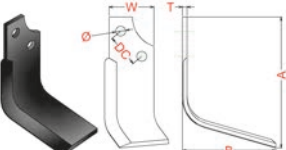
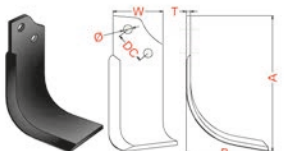
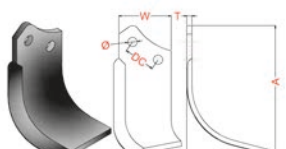
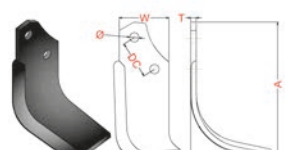



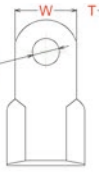

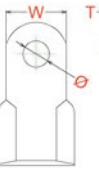

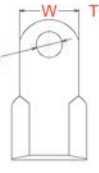



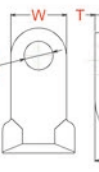

A B W T D.C. HOLE Ø gr.

MÁQUINA / TILLER MOD.

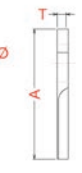
205 80 40 5 65 10,5 335

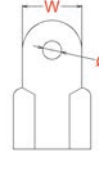
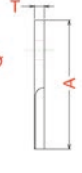
LANDER		DISEÑO/DESIGN		MEDIDAS / MEASUREMENTS (mm)				
REF. <b>302CC</b>		A	B	W	T	D.C.	HOLE Ø	gr
MÁQUINA / TILLER MOD.		190	75	40	5	65	10,5	315
REF. <b>303</b>		A	B	W	T	D.C.	HOLE Ø	gr
S-12 MÁQUINA / TILLER MOD.		155	50	40	6	33	10,5	290
REF. <b>321-C</b>		A	B	W	T	D.C.	HOLE Ø	gr
MÁQUINA / TILLER MOD.		210	65	45	6	65	10,5	446
REF. <b>321-L</b>		A	B	W	T	D.C.	HOLE Ø	gr
MÁQUINA / TILLER MOD.		220	93	45	6	65	10,5	515
LEON		DISEÑO/DESIGN						
REF. <b>PUA-1</b>		A	B	W	T	D.C.	HOLE Ø	gr
MÁQUINA / TILLER MOD.		260	0	60	12	46	17	1.330
REF. <b>PUA-2</b>		A	B	W	T	D.C.	HOLE Ø	gr
SINFILO MÁQUINA / TILLER MOD.		235	90	60	12	46	17	1.230
REF. <b>PUA-4</b>		A	B	W	T	D.C.	HOLE Ø	gr
MÁQUINA / TILLER MOD.		290	0	60	12	46	17	1.410
REF. <b>PUA-6</b>		A	B	W	T	D.C.	HOLE Ø	gr
MÁQUINA / TILLER MOD.		300	0	50	10	68,5	12,5	1.175
REF. <b>PUA-15</b>		A	B	W	T	D.C.	HOLE Ø	gr
MÁQUINA / TILLER MOD.		258	0	45	12	46	17	938
REF. <b>PUA-16</b>		A	B	W	T	D.C.	HOLE Ø	gr
MÁQUINA / TILLER MOD.		182	0	45	12	46	17	1.126

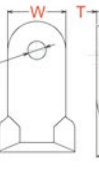
LEON		DISEÑO/DESIGN		MEDIDAS / MEASUREMENTS (mm)				
REF. <b>PUA-18</b>		A	B	W	T	D.C.	HOLE Ø	gf
MÁQUINA / TILLER MOD.		230	85	60	12	45	17	1.254
<b>MASCHIO</b>		<b>DISEÑO/DESIGN</b>		<b>MEDIDAS / MEASUREMENTS (mm)</b>				
REF. <b>332-S/F</b>		A	B	W	T	D.C.	HOLE Ø	gf
COBRA MÁQUINA / TILLER MOD.		238	40	50	12	51	17	1.020
REF. <b>626</b>		A	B	W	T	D.C.	HOLE Ø	gf
SUPER COBRA MÁQUINA / TILLER MOD.		181	44	80	8	45	14,5	850
REF. <b>646</b>		A	B	W	T	D.C.	HOLE Ø	gf
MÁQUINA / TILLER MOD.		210	145	80	8	56	14,5	1.380
REF. <b>659</b>		A	B	W	T	D.C.	HOLE Ø	gf
A / E MÁQUINA / TILLER MOD.		175	125	60	6	44	13,5	620
REF. <b>674</b>		A	B	W	T	D.C.	HOLE Ø	gf
A / E MÁQUINA / TILLER MOD.		190	112	70	6	44	12,5	735
REF. <b>680</b>		A	B	W	T	D.C.	HOLE Ø	gf
MÁQUINA / TILLER MOD.		200	130	80	$\frac{7}{8}$	48	14,5	$\frac{1.040}{1.140}$
REF. <b>695</b>		A	B	W	T	D.C.	HOLE Ø	gf
G MÁQUINA / TILLER MOD.		250	150	90	10	68	16,5	1.940
REF. <b>733</b>		A	B	W	T	D.C.	HOLE Ø	gf
MÁQUINA / TILLER MOD.		215	140	90	10	57	16,5	1.760
REF. <b>M-1</b>		A	B	W	T	D.C.	HOLE Ø	gf
TRITURADOR COLISO TIPO LARGO MÁQUINA / TILLER MOD.		106	44	40	8	0	30x14	250

MASCHIO		DISEÑO/DESIGN		MEDIDAS / MEASUREMENTS (mm)						
REF. <b>M-10</b> TRITURADOR				A	B	W	T	D.C.	HOLE Ø	gr.
MÁQUINA / TILLER MOD.				155	60	60	12	0	20,5	825
REF. <b>M-14</b>				A	B	W	T	D.C.	HOLE Ø	gr.
NORMAL MÁQUINA / TILLER MOD.				140	60	60	8	0	26	540
REF. <b>M-32</b>				A	B	W	T	D.C.	HOLE Ø	gr.
MÁQUINA / TILLER MOD.				145	60	60	8	0	26	560
REF. <b>DIENTE CUADRADO</b>				A	B	W	T	D.C.	HOLE Ø	gr.
B/C/SC MÁQUINA / TILLER MOD.				190	0	30	30	0	10,5	1.205
<b>MILA</b>		<b>DISEÑO/DESIGN</b>								
REF. <b>135-E</b>				A	B	W	T	D.C.	HOLE Ø	gr.
TR-140-160 MÁQUINA / TILLER MOD.				195	135	80	7	57	13,5	1.075
REF. <b>M-25</b> TRITURADOR				A	B	W	T	D.C.	HOLE Ø	gr.
MÁQUINA / TILLER MOD.				130	100	60	10	0	31	775
REF. <b>M-26</b> TRITURADOR				A	B	W	T	D.C.	HOLE Ø	gr.
RECTO MÁQUINA / TILLER MOD.				119	0	60	12	0	35	525
REF. <b>M-44</b> TRITURADOR				A	B	W	T	D.C.	HOLE Ø	gr.
MÁQUINA / TILLER MOD.				130	0	60	10	0	19	535
REF. <b>M-45</b> TRITURADOR				A	B	W	T	D.C.	HOLE Ø	gr.
MÁQUINA / TILLER MOD.				130	100	60	10	0	19	805



MOLLON		DISEÑO/DESIGN	MEDIDAS / MEASUREMENTS (mm)						
REF.			A	B	W	T	D.C.	HOLE Ø	g.f.
REF. 38-A			215	80	40	5	65-70	10,5 COLISO	360
MÁQUINA / TILLER MOD.									
REF. 70			205	75	45	5	70	8,5	425
940 MÁQUINA / TILLER MOD.									
REF. 178-ML			210	75	40	5	65-70	10,5 COLISO	370
1585/1078 1583/1087/1082 MÁQUINA / TILLER MOD.									
REF. 178-CD			210	70	40	5	65-70	9 COLISO	360
MÁQUINA / TILLER MOD.									
MOTOSTANDARD		DISEÑO/DESIGN	MEDIDAS / MEASUREMENTS (mm)						
REF.			A	B	W	T	D.C.	HOLE Ø	g.f.
REF. 758-L			220	70	35	5	65-70	8,5 COLISO	320
MÁQUINA / TILLER MOD.									
REF. 758			200	70	35	5	65-75	8,5 COLISO	285
MÁQUINA / TILLER MOD.									
MOVICAM		DISEÑO/DESIGN	MEDIDAS / MEASUREMENTS (mm)						
REF.			A	B	W	T	D.C.	HOLE Ø	g.f.
REF. 38-N			205	80	35	6	65-70	11 COLISO	370
M2 -100 M2 -152Z MÁQUINA / TILLER MOD.									
REF. 100-A			220	85	40	6	65-70	11 COLISO	360
M5/M4-DS MÁQUINA / TILLER MOD.									
REF. 100-N			220	85	35	6	65-70	11 COLISO	400
M4-DS-800 MÁQUINA / TILLER MOD.									

A = ALTURA B= CRUCE W = ANCHO T = ESPESOR D.C = DISTANCIA ENTRE CENTROS / A = LENGTH B= HEIGHT W = WIDTH T= THICKNESS D.C= DIST. BETWEEN CENTERS

MOVICAM		DISEÑO/DESIGN		MEDIDAS / MEASUREMENTS (mm)				
REF. <b>100-SA</b>		A	B	W	T	D.C.	HOLE Ø	GR
MÁQUINA / TILLER MOD.		220	85	50	6	65-70	10,5 COLISO	560
REF. <b>178-ML</b>		A	B	W	T	D.C.	HOLE Ø	GR
M2 -152 M2 -100 MÁQUINA / TILLER MOD.		210	75	40	5	65-70	10,5 COLISO	370
REF. <b>288</b>		A	B	W	T	D.C.	HOLE Ø	GR
MÁQUINA / TILLER MOD.		185	70	45	5	62-70	11 COLISO	340
REF. <b>350 GRANDE</b>		A	B	W	T	D.C.	HOLE Ø	GR
MÁQUINA / TILLER MOD.		210	80	45	6	50	10,5	460
MURATORI		DISEÑO/DESIGN		MEDIDAS / MEASUREMENTS (mm)				
REF. <b>445</b>		A	B	W	T	D.C.	HOLE Ø	GR
MÁQUINA / TILLER MOD.		145	75	60	6	42	12,5	450
REF. <b>448</b>		A	B	W	T	D.C.	HOLE Ø	GR
MÁQUINA / TILLER MOD.		180	115	70	6	47	13	735
REF. <b>483</b>		A	B	W	T	D.C.	HOLE Ø	GR
MS3-P MÁQUINA / TILLER MOD.		195	95	70	6	46	12,5	745
REF. <b>651</b>		A	B	W	T	D.C.	HOLE Ø	GR
M85-125 SPOST MÁQUINA / TILLER MOD.		145	115	50	6	28	10,5	440
REF. <b>655</b>		A	B	W	T	D.C.	HOLE Ø	GR
MÁQUINA / TILLER MOD.		170	145	80	8	46	14,5	1.190
REF. <b>M-8 TRITURADOR</b>		A	B	W	T	D.C.	HOLE Ø	GR
MÁQUINA / TILLER MOD.		125	55	40	8	0	21	325

MURATORI		DISEÑO/DESIGN	MEDIDAS / MEASUREMENTS (mm)						
REF. <b>M-15</b> TRITURADOR		A B W T D.C. HOLE Ø gfr	140	60	60	10	0	26	645
MÁQUINA / TILLER MOD.									
NARDI		DISEÑO/DESIGN	MEDIDAS / MEASUREMENTS (mm)						
REF. <b>491</b>		A B W T D.C. HOLE Ø gfr	172	135	80	7	55	14,5	1.085
MÁQUINA / TILLER MOD.									
REF. <b>622</b>		A B W T D.C. HOLE Ø gfr	180	106	70	6	45	12,5	705
MÁQUINA / TILLER MOD.									
REF. <b>623</b>		A B W T D.C. HOLE Ø gfr	198	135	80	7	55	14,5	1.015
MÁQUINA / TILLER MOD.									
REF. <b>678</b>		A B W T D.C. HOLE Ø gfr	197	110	60	6	45	12,5	640
MÁQUINA / TILLER MOD.									
REF. <b>710</b>		A B W T D.C. HOLE Ø gfr	184	140	80	7	55	14,5	965
MÁQUINA / TILLER MOD.									
NIBBIBRUNO		DISEÑO/DESIGN	MEDIDAS / MEASUREMENTS (mm)						
REF. <b>413</b>		A B W T D.C. HOLE Ø gfr	160	75	50	6	40	8,5	425
MÁQUINA / TILLER MOD.									
REF. <b>415</b>		A B W T D.C. HOLE Ø gfr	155	80	50	6	41	10,5	405
MÁQUINA / TILLER MOD.									
REF. <b>476</b>		A B W T D.C. HOLE Ø gfr	190	50	30	5	50-57	9 COLISO	250
TOP MAX 305 MÁQUINA / TILLER MOD.									

A = ALTURA B= CRUCE W = ANCHO T = ESPESOR D.C. = DISTANCIA ENTRE CENTROS / A = LENGTH B= HEIGHT W= WIDTH T= THICKNESS D.C.= DIST. BETWEEN CENTERS

ORSI		DISEÑO/DESIGN		MEDIDAS / MEASUREMENTS (mm)				
REF. <b>M-1</b> TRITURADOR		A	B	W	T	D.C.	HOLE Ø	
MÁQUINA / TILLER MOD.		106	44	40	8	0	30X14 COLISO	250
REF. <b>M-6</b> TRITURADOR		A	B	W	T	D.C.	HOLE Ø	
RECTO MÁQUINA / TILLER MOD.		135	0	60	8	0	17	450
REF. <b>M-7</b> TRITURADOR		A	B	W	T	D.C.	HOLE Ø	
MÁQUINA / TILLER MOD.		142	60	60	8	0	17	555
REF. <b>M-9</b> TRITURADOR		A	B	W	T	D.C.	HOLE Ø	
MÁQUINA / TILLER MOD.		147	40	40	8	0	21	370
REF. <b>M-27</b> TRITURADOR		A	B	W	T	D.C.	HOLE Ø	
MÁQUINA / TILLER MOD.		150	96	60	10	0	26	950
ORTOLAN		DISEÑO/DESIGN		MEDIDAS / MEASUREMENTS (mm)				
REF. <b>624</b>		A	B	W	T	D.C.	HOLE Ø	
MÁQUINA / TILLER MOD.		190	90	60	6	40-44	13 COLISO	565
REF. <b>710</b>		A	B	W	T	D.C.	HOLE Ø	
MÁQUINA / TILLER MOD.		184	140	80	7	55	14,5	965
REF. <b>718</b>		A	B	W	T	D.C.	HOLE Ø	
MÁQUINA / TILLER MOD.		180	90	70	6	65	12,5	605
OVAC		DISEÑO/DESIGN		MEDIDAS / MEASUREMENTS (mm)				
REF. <b>28</b>		A	B	W	T	D.C.	HOLE Ø	
MOTO- BINADORA MÁQUINA / TILLER MOD.		190	60	30	5	70	10,5	220

OVAC		DISEÑO/DESIGN		MEDIDAS / MEASUREMENTS (mm)				
REF. <b>178-CD</b>		A	B	W	T	D.C.	HOLE Ø	gfr
T-88 MÁQUINA / TILLER MOD.		210	70	40	5	65-75	9 COLISO	360
<b>PASBO</b>		DISEÑO/DESIGN		MEDIDAS / MEASUREMENTS (mm)				
REF. <b>38-AC</b>		A	B	W	T	D.C.	HOLE Ø	gfr
G11/14/ 72/83/84 MÁQUINA / TILLER MOD.		200	75	40	6	68-73	10,5 COLISO	415
REF. <b>100-A</b>		A	B	W	T	D.C.	HOLE Ø	gfr
G11/ 14/ 72/83/84 MÁQUINA / TILLER MOD.		220	85	40	6	65-70	11 COLISO	455
REF. <b>288</b>		A	B	W	T	D.C.	HOLE Ø	gfr
G14/ G -84 MÁQUINA / TILLER MOD.		185	70	45	5	62-70	11 COLISO	340
<b>PASQUALI</b>		DISEÑO/DESIGN		MEDIDAS / MEASUREMENTS (mm)				
REF. <b>38-E</b>		A	B	W	T	D.C.	HOLE Ø	gfr
FRESA 532 MÁQUINA / TILLER MOD.		205	80	35	6	61,5-71	11 COLISO	350
REF. <b>64-2T</b>		A	B	W	T	D.C.	HOLE Ø	gfr
21 CV MÁQUINA / TILLER MOD.		200	110	70	6	42	12,5	720
REF. <b>172-C</b>		A	B	W	T	D.C.	HOLE Ø	gfr
MOD.TP MÁQUINA / TILLER MOD.		165	90	50	6	35	10,5	470
REF. <b>172-M</b>		A	B	W	T	D.C.	HOLE Ø	gfr
MÁQUINA / TILLER MOD.		160	100	60	6	35	13	560
REF. <b>198-CPD</b>		A	B	W	T	D.C.	HOLE Ø	gfr
MÁQUINA / TILLER MOD.		190	85	60	6	42	12,5	555

PASQUALI		DISEÑO/DESIGN	MEDIDAS / MEASUREMENTS (mm)						
REF. <b>198-CTD</b>		A	B	W	T	D.C.	HOLE Ø	gr	
588 MÁQUINA / TILLER MOD.		185	90	60	6	42	12,5	520	
REF. <b>198-CTF</b>		A	B	W	T	D.C.	HOLE Ø	gr	
595 MÁQUINA / TILLER MOD.		185	90	60	6	42	12,5	515	
REF. <b>198 CTF PQ</b>		A	B	W	T	D.C.	HOLE Ø	gr	
588 MÁQUINA / TILLER MOD.		165	90	60	6	42	12,5	465	
REF. <b>198-E</b>		A	B	W	T	D.C.	HOLE Ø	gr	
595 LEVANTE MÁQUINA / TILLER MOD.		175	95	60	6	42	12,5	560	
REF. <b>198-ENT</b>		A	B	W	T	D.C.	HOLE Ø	gr	
595 595-42 MÁQUINA / TILLER MOD.		195	95	60	6	42	12,5	665	
REF. <b>198-PCT</b>		A	B	W	T	D.C.	HOLE Ø	gr	
913 MÁQUINA / TILLER MOD.		155	60	50	6	32	10,5	390	
REF. <b>214-EL</b>		A	B	W	T	D.C.	HOLE Ø	gr	
FRESA 588 528 ITALIA MÁQUINA / TILLER MOD.		230	90	40	6	80	10,5	485	
REF. <b>606-C</b>		A	B	W	T	D.C.	HOLE Ø	gr	
MÁQUINA / TILLER MOD.		210	140	100	10	75	16,5	2.010	
<b>PEYMA</b>		<b>DISEÑO/DESIGN</b>							
REF. <b>100-N</b>		A	B	W	T	D.C.	HOLE Ø	gr	
MÁQUINA / TILLER MOD.		220	85	35	6	65-70	10,5 COLISO	400	
REF. <b>129-P</b>		A	B	W	T	D.C.	HOLE Ø	gr	
MÁQUINA / TILLER MOD.		207	80	35	6	48	10,5	380	

PEYMA		DISEÑO/DESIGN		MEDIDAS / MEASUREMENTS (mm)				
REF. 200-CM		A	B	W	T	D.C.	HOLE Ø	g
MÁQUINA / TILLER MOD.		195	75	30	5	45-50	10,5 COLISO	265
REF. 205		A	B	W	T	D.C.	HOLE Ø	g
MÁQUINA / TILLER MOD.		180	65	30	5	45-50	10,5 COLISO	235
REF. 228-C		A	B	W	T	D.C.	HOLE Ø	g
MÁQUINA / TILLER MOD.		185	80	30	5	48	10,5	250
PIVA		DISEÑO/DESIGN						
REF. 109		A	B	W	T	D.C.	HOLE Ø	g
M-9 MÁQUINA / TILLER MOD.		230	85	40	5	80	10,5	390
REF. 112		A	B	W	T	D.C.	HOLE Ø	g
M-6 MÁQUINA / TILLER MOD.		190	62	30	5	50-58	9 COLISO	236
REF. 178 CD		A	B	W	T	D.C.	HOLE Ø	g
MÁQUINA / TILLER MOD.		210	70	40	5	65-75	9 COLISO	360
REVERSIBLES UNIVERSALES								
REF. 724		A	B	W	T	D.C.	HOLE Ø	g
MÁQUINA / TILLER MOD.		190	50 DOBLE FILO	30	5	60-70	8,5 COLISO	220
REF. 725		A	B	W	T	D.C.	HOLE Ø	g
MÁQUINA / TILLER MOD.		210	55 DOBLE FILO	35	5	65-75	8,5 COLISO	295
ROTECO		DISEÑO/DESIGN						
REF. 349		A	B	W	T	D.C.	HOLE Ø	g
MÁQUINA / TILLER MOD.		200	75	45	6	68-72	10,5 COLISO	460

A = ALTURA B= CRUCE W= ANCHO T= ESPESOR D.C.= DISTANCIA ENTRE CENTROS / A = LENGTH B= HEIGHT W= WIDTH T= THICKNESS D.C.= DIST. BETWEEN CENTERS



ROTECO		DISEÑO/DESIGN		MEDIDAS / MEASUREMENTS (mm)				
REF. 349-A		A	B	W	T	D.C.	HOLE Ø	gr
MÁQUINA / TILLER MOD.		200	80	35	5	68	10,5	305
REF. 349-A		A	B	W	T	D.C.	HOLE Ø	gr
MÁQUINA / TILLER MOD.		200	80	45	6	62-70	11 COLISO	460
REF. 349-A		A	B	W	T	D.C.	HOLE Ø	gr
MÁQUINA / TILLER MOD.		205	85	50	6	62-70	11 COLISO	530
REF. 349-A		A	B	W	T	D.C.	HOLE Ø	gr
MÁQUINA / TILLER MOD.		180	70	30	5	68	10,5	230
SEP		DISEÑO/DESIGN						
REF. 25-S		A	B	W	T	D.C.	HOLE Ø	gr
MÁQUINA / TILLER MOD.		195	60	30	5	65-70	9 COLISO	240
REF. 38-E		A	B	W	T	D.C.	HOLE Ø	gr
MÁQUINA / TILLER MOD.		200	75	35	6	61,5-71	11 COLISO	350
REF. 38-N		A	B	W	T	D.C.	HOLE Ø	gr
MÁQUINA / TILLER MOD.		205	80	35	6	65-70	11 COLISO	370
REF. 178-B		A	B	W	T	D.C.	HOLE Ø	gr
MÁQUINA / TILLER MOD.		215	70	40	5	70	10,5	350
REF. 254		A	B	W	T	D.C.	HOLE Ø	gr
MÁQUINA / TILLER MOD.		145	100	50	6	25	10,5	400
REF. 254-A		A	B	W	T	D.C.	HOLE Ø	gr
MÁQUINA / TILLER MOD.		140	100	50	6	25	10,5	425

SEP		DISEÑO/DESIGN		MEDIDAS / MEASUREMENTS (mm)				
REF. 353		A	B	W	T	D.C.	HOLE Ø	gr
MÁQUINA / TILLER MOD.		185	80	50	6	62-70	11 COLISO	425
REF. 394		A	B	W	T	D.C.	HOLE Ø	gr
MÁQUINA / TILLER MOD.		187	60	35	5	63-70	9	275
REF. 704		A	B	W	T	D.C.	HOLE Ø	gr
MÁQUINA / TILLER MOD.		193	60	35	6	56	9	350
SICMA		DISEÑO/DESIGN		MEDIDAS / MEASUREMENTS (mm)				
REF. 709		A	B	W	T	D.C.	HOLE Ø	gr
SM MÁQUINA / TILLER MOD.		185	130	80	8	57	14,5	1.005
REF. 710		A	B	W	T	D.C.	HOLE Ø	gr
SM MÁQUINA / TILLER MOD.		184	140	80	7	55	14,5	965
REF. M-1 TRITURADOR		A	B	W	T	D.C.	HOLE Ø	gr
MÁQUINA / TILLER MOD.		106	44	40	8	0	30X14 COLISO	250
REF. M-14 TRITURADOR		A	B	W	T	D.C.	HOLE Ø	gr
MÁQUINA / TILLER MOD.		140	60	60	8	0	26	540
SIMON		DISEÑO/DESIGN		MEDIDAS / MEASUREMENTS (mm)				
REF. 447		A	B	W	T	D.C.	HOLE Ø	gr
MÁQUINA / TILLER MOD.		300	55	50	10	96-103	15 COLISO	1.090
REF. 672-L		A	B	W	T	D.C.	HOLE Ø	gr
MÁQUINA / TILLER MOD.		250	60	35	8	73-77	11 COLISO	530

A = ALTURA B= CRUCE W= ANCHO T = ESPESOR D.C = DISTANCIA ENTRE CENTROS / A = LENGTH B= HEIGHT W= WIDTH T= THICKNESS D.C= DIST. BETWEEN CENTERS

SIMON		DISEÑO/DESIGN		MEDIDAS / MEASUREMENTS (mm)				
REF. 672-C		A	B	W	T	D.C.	HOLE Ø	gr.
MÁQUINA / TILLER MOD.		225	60	35	8	73-77	11 COLISO	470
REF. 715		A	B	W	T	D.C.	HOLE Ø	gr.
MÁQUINA / TILLER MOD.		195	90	60	6	42	12,5	615
REF. 716-R		A	B	W	T	D.C.	HOLE Ø	gr.
MÁQUINA / TILLER MOD.		215	0	60	6	42	12,5	550
SOLO		DISEÑO/DESIGN		MEDIDAS / MEASUREMENTS (mm)				
REF. 44		A	B	W	T	D.C.	HOLE Ø	gr.
MÁQUINA / TILLER MOD.		200	60	30	5	70	8,5	260
REF. 164-C		A	B	W	T	D.C.	HOLE Ø	gr.
565 MÁQUINA / TILLER MOD.		140	90	50	6	29	10,5	385
REF. 164-MTY		A	B	W	T	D.C.	HOLE Ø	gr.
565 MÁQUINA / TILLER MOD.		170	80	50	6	29	10,5	480
REF. 178-CD		A	B	W	T	D.C.	HOLE Ø	gr.
MÁQUINA / TILLER MOD.		210	70	40	5	65-75	9 COLISO	360
SOVEMA		DISEÑO/DESIGN		MEDIDAS / MEASUREMENTS (mm)				
REF. 172-C		A	B	W	T	D.C.	HOLE Ø	gr.
MÁQUINA / TILLER MOD.		160	90	50	6	35	10,5	470
REF. 448		A	B	W	T	D.C.	HOLE Ø	gr.
MÁQUINA / TILLER MOD.		180	113	70	6	47	13	735

**SOVEMA**

**DISEÑO/DESIGN**

**MEDIDAS / MEASUREMENTS (mm)**

REF. **455**

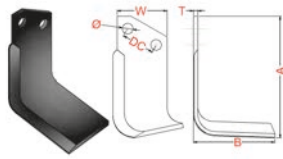

A	B	W	T	D.C.	HOLE Ø	gfr
170	114	70	6	46	15	745

MÁQUINA / TILLER MOD.

REF. **655**

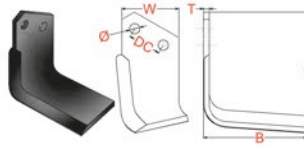

A	B	W	T	D.C.	HOLE Ø	gfr
170	145	80	8	46	14,5	1.190

MÁQUINA / TILLER MOD.

**TRUSS**

**DISEÑO/DESIGN**

REF. **38-A**

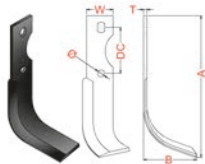

A	B	W	T	D.C.	HOLE Ø	gfr
215	80	40	5	65-70	10,5 COLISO	360

MÁQUINA / TILLER MOD.

REF. **38-AC**

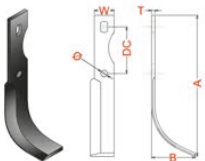

A	B	W	T	D.C.	HOLE Ø	gfr
200	75	40	6	65-70	10,5 COLISO	415

MÁQUINA / TILLER MOD.

REF. **38-N**

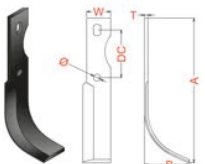

A	B	W	T	D.C.	HOLE Ø	gfr
205	80	35	6	65-70	11 COLISO	370

MÁQUINA / TILLER MOD.

REF. **100-A**

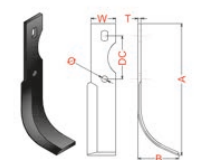

A	B	W	T	D.C.	HOLE Ø	gfr
220	85	40	6	65-70	11 COLISO	455

MÁQUINA / TILLER MOD.

REF. **100-SA**

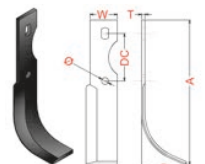

A	B	W	T	D.C.	HOLE Ø	gfr
220	85	50	6	65-70	10,5 COLISO	560

MÁQUINA / TILLER MOD.

REF. **178-ML**

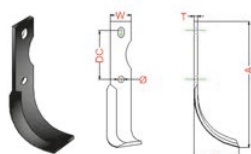

A	B	W	T	D.C.	HOLE Ø	gfr
210	75	40	6	65-70	10,5 COLISO	370

TG  
MÁQUINA / TILLER MOD.

REF. **288**

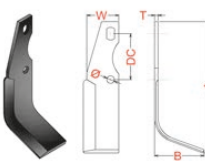

A	B	W	T	D.C.	HOLE Ø	gfr
185	70	45	5	62-70	11 COLISO	340











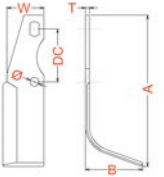

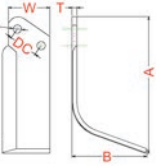

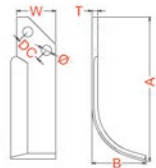

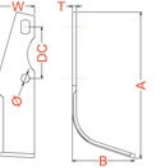
5102  
MÁQUINA / TILLER MOD.

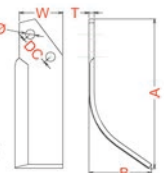
REF. **288-L**

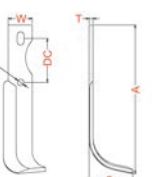

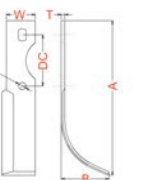
A	B	W	T	D.C.	HOLE Ø	gfr
215	70	45	6	68-72	11 COLISO	465

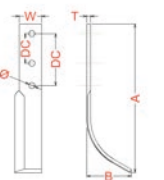
MÁQUINA / TILLER MOD.

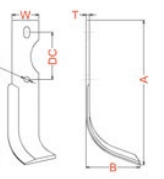
TRUSS		DISEÑO/DESIGN		MEDIDAS / MEASUREMENTS (mm)					
REF. <b>288-P</b>			A	B	W	T	D.C.	HOLE Ø	gr.
5102 MÁQUINA / TILLER MOD.			185	80	45	6	62-70	11 COLISO	395
<b>VALPADANA</b>		<b>DISEÑO/DESIGN</b>							
REF. <b>172-C</b>			A	B	W	T	D.C.	HOLE Ø	gr.
VMC-14 MÁQUINA / TILLER MOD.			160	90	50	6	35	10,5	470
REF. <b>343-P</b>			A	B	W	T	D.C.	HOLE Ø	gr.
VMC-130 MÁQUINA / TILLER MOD.			140	80	40	6	27	10,5	295
REF. <b>353</b>			A	B	W	T	D.C.	HOLE Ø	gr.
VMC-150 MÁQUINA / TILLER MOD.			185	80	50	6	62-70	11 COLISO	425
REF. <b>414</b>			A	B	W	T	D.C.	HOLE Ø	gr.
VMC-15 MÁQUINA / TILLER MOD.			170	75	50	6	35	11	425
REF. <b>476</b>			A	B	W	T	D.C.	HOLE Ø	gr.
MÁQUINA / TILLER MOD.			190	50	30	5	50-57	9 COLISO	250
<b>V.H.</b>		<b>DISEÑO/DESIGN</b>							
REF. <b>38 VH</b>			A	B	W	T	D.C.	HOLE Ø	gr.
MÁQUINA / TILLER MOD.			205	65	40	5	68-72	10,5 COLISO	325
REF. <b>44 VH</b>			A	B	W	T	D.C.	HOLE Ø	gr.
3 TAL MÁQUINA / TILLER MOD.			200	60	30	5	40-70	8,5	260
REF. <b>178-CD</b>			A	B	W	T	D.C.	HOLE Ø	gr.
MÁQUINA / TILLER MOD.			210	70	40	5	65-75	9 COLISO	360

V.H.		DISEÑO/DESIGN		MEDIDAS / MEASUREMENTS (mm)					
REF.	MÁQUINA / TILLER MOD.		A	B	W	T	D.C.	HOLE Ø	gfr
REF. 454			170	45	35	5	65-73	8,5 COLISO	240
MÁQUINA / TILLER MOD.									
VOLPINO		DISEÑO/DESIGN		MEDIDAS / MEASUREMENTS (mm)					
REF.	MÁQUINA / TILLER MOD.		A	B	W	T	D.C.	HOLE Ø	gfr
REF. 100-A			220	85	40	6	65-70	11,0 COLISO	455
MÁQUINA / TILLER MOD.									
REF. 100-SA			220	85	50	6	65-70	11,0 COLISO	560
MÁQUINA / TILLER MOD.									
REF. 195-BABY			165	54	30	5	65-70	9 COLISO	206
BINADORA 410 MÁQUINA / TILLER MOD.									
REF. 195-C			165	50	30	5	65-70	8,5 COLISO	176
BINADORA 410 MÁQUINA / TILLER MOD.									
REF. 280-TD			205	60	45	5	67-73	8,5 COLISO	365
125 MÁQUINA / TILLER MOD.									
REF. 321-L			220	93	45	6	65	10,5	515
MÁQUINA / TILLER MOD.									
REF. 349			205	80	45	6	68-72	10,5 COLISO	430
MÁQUINA / TILLER MOD.									
YAMMAR		DISEÑO/DESIGN		MEDIDAS / MEASUREMENTS (mm)					
REF.	MÁQUINA / TILLER MOD.		A	B	W	T	D.C.	HOLE Ø	gfr
REF. 336-CM			195	75	35	5	70	8,5	295
MÁQUINA / TILLER MOD.									

YAMMAR		DISEÑO/DESIGN		MEDIDAS / MEASUREMENTS (mm)				
REF. 340		A	B	W	T	D.C.	HOLE Ø	gr.
MÁQUINA / TILLER MOD.		230	80	35	5	80	10,5	350
REF. 340-TC		A	B	W	T	D.C.	HOLE Ø	gr.
MÁQUINA / TILLER MOD.		230	80	35	5	70	9	355
REF. 355		A	B	W	T	D.C.	HOLE Ø	gr.
MÁQUINA / TILLER MOD.		245	80	35	5	80	10,5	380
ZANÓN		DISEÑO/DESIGN		MEDIDAS / MEASUREMENTS (mm)				
REF. M-1 TRITURADOR		A	B	W	T	D.C.	HOLE Ø	gr.
MÁQUINA / TILLER MOD.		106	44	40	8	0	30X14 COLISO	250
REF. M-4/21 TRITURADOR		A	B	W	T	D.C.	HOLE Ø	gr.
MÁQUINA / TILLER MOD.		114	52	40	8	0	21	295
REF. M-14 TRITURADOR		A	B	W	T	D.C.	HOLE Ø	gr.
MÁQUINA / TILLER MOD.		140	60	60	8	0	26	540
VARIOS		DISEÑO/DESIGN		MEDIDAS / MEASUREMENTS (mm)				
REF. 304		A	B	W	T	D.C.	HOLE Ø	gr.
MÁQUINA / TILLER MOD.		190	90	70	7	65	12,5	725
REF. 406		A	B	W	T	D.C.	HOLE Ø	gr.
MÁQUINA / TILLER MOD.		170	90	50	6	34	10,5	440
REF. 407		A	B	W	T	D.C.	HOLE Ø	gr.
MÁQUINA / TILLER MOD.		150	90	50	6	38	10,5	380



VARIOS		DISEÑO/DESIGN	MEDIDAS / MEASUREMENTS (mm)						
REF.			A	B	W	T	D.C.	HOLE Ø	gf.
REF. 408			175	110	60	6	40-44	13,0 COLISO	605
MÁQUINA / TILLER MOD.									
REF. 409			175	80	60	6	38-48	9,5	480
MÁQUINA / TILLER MOD.									
REF. 410			225	120	60	7	85	13,5	835
MÁQUINA / TILLER MOD.									
REF. 411			255	105	50	6	115	13	700
MÁQUINA / TILLER MOD.									
REF. 429			168	110	60	6	40	13	570
MÁQUINA / TILLER MOD.									
REF. 433			180	140	80	7	57	14,5	1.125
MÁQUINA / TILLER MOD.									
REF. 435			250	85	50	6	84	11	625
MÁQUINA / TILLER MOD.									
REF. 436			170	75	50	6	51-62	10,5 COLISO	430
MÁQUINA / TILLER MOD.									
REF. 439			170	80	50	6	25-40	11,0 COLISO	430
MÁQUINA / TILLER MOD.									
REF. 440			230	60	50	6	72-82	11,0 COLISO	560
MÁQUINA / TILLER MOD.									

A = ALTURA B= CRUCE W = ANCHO T = ESPESOR D.C = DISTANCIA ENTRE CENTROS / A = LENGTH B= HEIGHT W = WIDTH T = THICKNESS D.C= DIST. BETWEEN CENTERS

VARIOS		DISEÑO/DESIGN	MEDIDAS / MEASUREMENTS (mm)						
REF.			A	B	W	T	D.C.	HOLE Ø	gr.
REF. 482-L			200	50	25	10	0	11	590
MÁQUINA / TILLER MOD.									
REF. 482-NI			180	55	25	10	0	11	450
MÁQUINA / TILLER MOD.									
REF. 482-C			203	45	22	9	0	11	430
MÁQUINA / TILLER MOD.									
REF. 489-C			200	60	35	5	70	9	300
MÁQUINA / TILLER MOD.									
REF. 489-L			195	80	35	5	70	9	310
MÁQUINA / TILLER MOD.									
REF. 510			190	140	80	7	50-57	13 COLISO	1.100
MÁQUINA / TILLER MOD.									
REF. 668			295	95	30	10	0	5	640
APARTA TERRONES MÁQUINA / TILLER MOD.									
REF. 728			195	110	70	6	40-45	13 COLISO	735
MÁQUINA / TILLER MOD.									
REF. 729			210	75	40	5	65-74	9 COLISO	350
MÁQUINA / TILLER MOD.									
REF. 730			220	85	45	6	85	11	525
MÁQUINA / TILLER MOD.									

VARIOS		DISEÑO/DESIGN	MEDIDAS / MEASUREMENTS (mm)						
REF.			A	B	W	T	D.C.	HOLE Ø	gf.
REF. 731			235	130	100	8	75	16,5	1.670
MÁQUINA / TILLER MOD.									
REF. 732			240	75	35	5	75-90	10,5 COLISO	345
MÁQUINA / TILLER MOD.									
REF. 734			90	0	35	5	1 TALADRO	10,5	115
MÁQUINA / TILLER MOD.									
REF. 735			360	45	70	10	150	17	1.825
MÁQUINA / TILLER MOD.									
REF. 758-C			200	70	35	5	65-75	8,5 COLISO	295
MÁQUINA / TILLER MOD.									
REF. 758-L			200	70	35	5	65-75	8,5 COLISO	295
MÁQUINA / TILLER MOD.									
REF. 818			215	140	80	8	56	14,5	1.340
MÁQUINA / TILLER MOD.									
REF. 723			185	135	90	10	50	16,5	1.490
MÁQUINA / TILLER MOD.									
REF. 727			185	135	100	10	75	17	1.740
MÁQUINA / TILLER MOD.									
REF. 820			210	150	80	10	56	14,5	1.650
MÁQUINA / TILLER MOD.									

A = ALTURA B= CRUCE W = ANCHO T = ESPESOR D.C = DISTANCIA ENTRE CENTROS / A = LENGTH B= HEIGHT W= WIDTH T= THICKNESS D.C= DIST. BETWEEN CENTERS

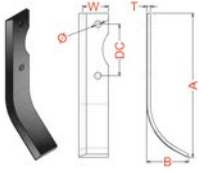
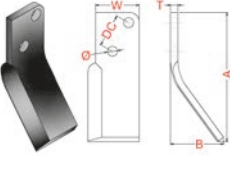
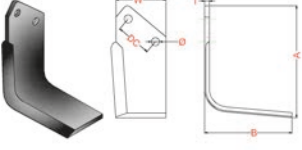
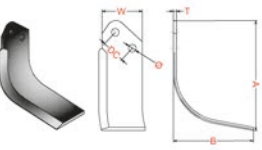
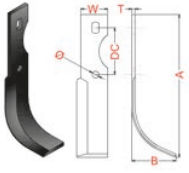
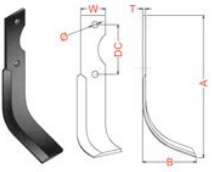
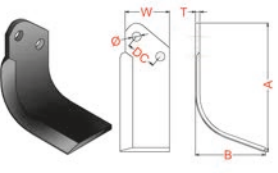
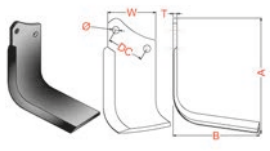
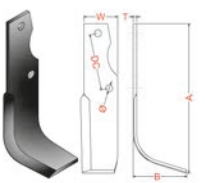
VARIOS		DISEÑO/DESIGN		MEDIDAS / MEASUREMENTS (mm)				
REF. 823		A	B	W	T	D.C.	HOLE Ø	g
MÁQUINA / TILLER MOD.		195	60	35	5	70	9	280
REF. 824		A	B	W	T	D.C.	HOLE Ø	g
MÁQUINA / TILLER MOD.		210	80	70	$\frac{10}{12}$	57	17	$\frac{1.190}{1.435}$
JSC		DISEÑO/DESIGN		MEDIDAS / MEASUREMENTS (mm)				
REF. 2-REC		A	B	W	T	D.C.	HOLE Ø	g
JSC MÁQUINA / TILLER MOD.		180	140	80	8	57	13,5	1.225
REF. 10-C		A	B	W	T	D.C.	HOLE Ø	g
JSC MÁQUINA / TILLER MOD.		145	135	60	6	36	11,75	670
REF. 100-A		A	B	W	T	D.C.	HOLE Ø	g
JSC MÁQUINA / TILLER MOD.		220	85	40	6	65-70	11,0 COLISO	455
REF. 109		A	B	W	T	D.C.	HOLE Ø	g
JSC MÁQUINA / TILLER MOD.		230	85	40	5	80	10,5	390
REF. 198-E		A	B	W	T	D.C.	HOLE Ø	g
JSC MÁQUINA / TILLER MOD.		175	95	60	6	42	12,5	560
REF. 207-E		A	B	W	T	D.C.	HOLE Ø	g
JSC MÁQUINA / TILLER MOD.		180	135	75	6	57	11,5	900
REF. 234		A	B	W	T	D.C.	HOLE Ø	g
JSC MÁQUINA / TILLER MOD.		265	95	60	6	100	12,5	755

JSC		DISEÑO/DESIGN		MEDIDAS / MEASUREMENTS (mm)				
REF.		A	B	W	T	D.C.	HOLE Ø	gr.
REF. 315		237	58	60	10	0	17	1.080
JSC	MÁQUINA / TILLER MOD.							
REF. 315-2		230	70	60	10/12	46	15	1.050
JSC	MÁQUINA / TILLER MOD.							
REF. 332		238	40	50	12	51	17	1.020
JSC	MÁQUINA / TILLER MOD.							
REF. 336-CM		195	75	35	5	70	8,5	295
JSC	MÁQUINA / TILLER MOD.							
REF. 602		180	140	80	9	51	16,5	1.510
JSC	MÁQUINA / TILLER MOD.							
REF. 618		185	145	90	10	57	16,5	1.450
JSC	MÁQUINA / TILLER MOD.							
REF. 630		185	150	80	10	57	16,5	1.580
JSC	MÁQUINA / TILLER MOD.							
REF. 646		210	145	80	8	56	14,5	1.380
JSC	MÁQUINA / TILLER MOD.							
REF. 693		185	135	80	8	57	14,5	1.130
JSC	MÁQUINA / TILLER MOD.							





# **CUCHILLAS TRITURADOR**



**Crusher blades / Lames broyeur**



REF.	DISEÑO/DESIGN	MEDIDAS / MEASUREMENTS (mm)					
M-1/R		A	B	W	T	HOLE Ø	gr.
		104	0	40	8	30x14	250
M-2		A	B	W	T	HOLE Ø	gr.
		80	40	40	8	30x14	196
M-3		A	B	W	T	HOLE Ø	gr.
		98	48	50	8	34x15	300
M-5		A	B	W	T	HOLE Ø	gr.
		130	60	$\frac{50}{60}$	8	17	$\frac{430}{500}$
M-11		A	B	W	T	HOLE Ø	gr.
		152	42	60	8	21	555
M-12		A	B	W	T	HOLE Ø	gr.
		245	60	60	8	23	935
M-16		A	B	W	T	HOLE Ø	gr.
		140	0	60	10	26	582
M-21		A	B	W	T	HOLE Ø	gr.
		148	40	60	8	28	496
M-21		A	B	W	T	HOLE Ø	gr.
		145	39	60	8	31	496
M-22 NORMAL		A	B	W	T	HOLE Ø	gr.
		140	60	60	8	29	470

REF.	DISEÑO/DESIGN	MEDIDAS / MEASUREMENTS (mm)					
		A	B	W	T	HOLE Ø	gr.
M-33		140	0	60	8	36	530
M-34		142	0	60	8	16,5	530
M-35		155	43	50	8	21	520
M-36		98	43	40	12	34x17	335
M-37		225	60	60	8	28	820
M-38		100	30	30	5	11	120
M-39		100	85	60	8	26	535
M-40		132	42	40	8	17	330
M-41		124	34	40	10	39x14,5	345

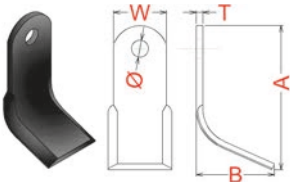
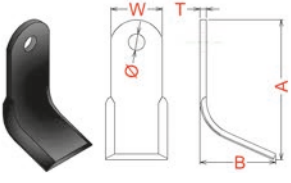
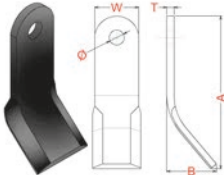
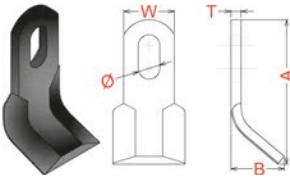
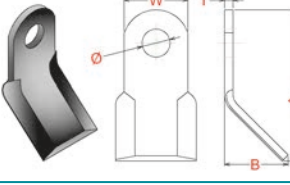
A = ALTURA B = CRUCE W = ANCHO T = ESPESOR / A = LENGTH B = HEIGHT W = WIDTH T = THICKNESS

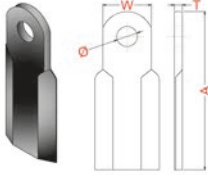
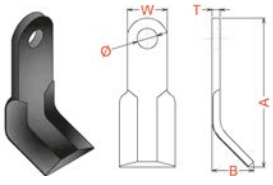
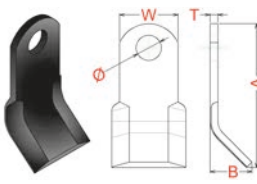
REF.	DISEÑO/DESIGN	MEDIDAS / MEASUREMENTS (mm)					
		A	B	W	T	HOLE Ø	gr.
M-42		107	57	40	5	13	210
M-43		142	50	40	5	15	250
M-46		105	32	30	5	10,5	125
M-47 COLISO		114	42	40	8	35X17	275
M-49		150	55	60	12	21	820
M-50		125	52	40	10	17	410
M-51		125	0	40	10	17	360
M-52		204	53	60	10	26	945
M-53		142	53	40	5	15	250

REF.	DISEÑO/DESIGN	MEDIDAS / MEASUREMENTS (mm)					
		A	B	W	T	HOLE Ø	gr.
M-54		144	46	60	8	26	545
M-55 RECTO		144	0	60	8	26	485
M-56		154	74	60	10	26	770
M-57 RECTO		160	0	60	8	26	540
M-58		205	64	60	8	26	815
M-59 RECTO		210	0	60	8	26	715
M-60		205	49	60	8	26	750
M-61		100	44	40	5	13	164
M-62		96	47	35	5	13	145

A = ALTURA B = CRUCE W = ANCHO T = ESPESOR / A = LENGTH B = HEIGHT W = WIDTH T = THICKNESS





# **CUCHILLAS DESBROZADORAS**

**Brushcutters blades / Lames débroussailleuses**

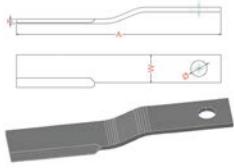
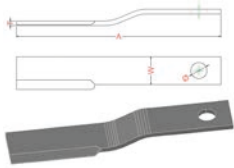
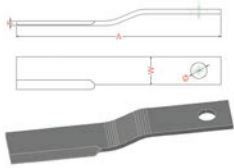
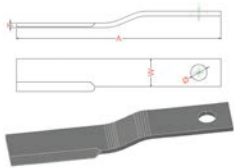
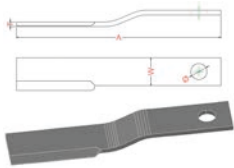
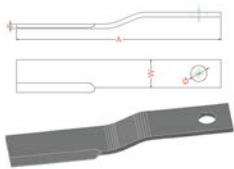
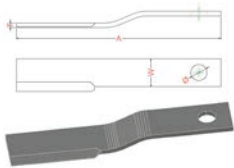
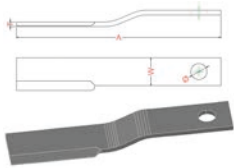
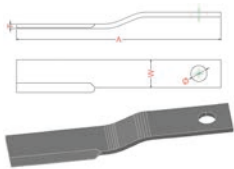
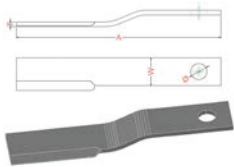

REF.	DISEÑO/DESIGN	MEDIDAS / MEASUREMENTS (mm)				
		W	T	A	HOLE Ø	gr.
CH-2		60	10	430	35	2.070
CH-3		60	10	440	30	2.088
CH-4		60	10	530	35	2.355
CH-5		60	10	620	35	2.870
CH-6		70	10	490	30	2.557
CH-7		70	10	490	35	2.557
CH-8		70	10	540	35	2.760
CH-9		70	10	570	35	2.980 gr
CH-10		70	10	620	35	3.358
CH-11		60	8	370	30,5	1.190

W= ANCHO T= ESPESOR A= ALTURA / W= WIDTH T= THICKNESS A= LENGTH

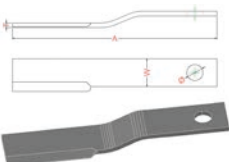
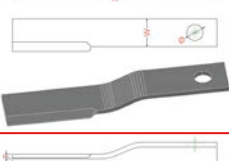
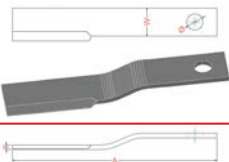
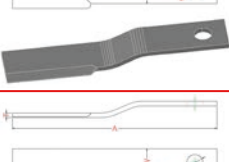
REF.	DISEÑO/DESIGN	MEDIDAS / MEASUREMENTS (mm)				
CH-12		W	T	A	HOLE Ø	gr.
		70	10	560	35	3.017
CH-13		W	T	A	HOLE Ø	gr.
		70	10	610	35	3.348
CH-14		W	T	A	HOLE Ø	gr.
		70	10	660	35	3.410
CH-15		W	T	A	HOLE Ø	gr.
		70	10	670	35	3.770
CH-16		W	T	A	HOLE Ø	gr.
		70	10	720	35	3.890
CH-17		W	T	A	HOLE Ø	gr.
		70	10	480	35	2.152
CH-18		W	T	A	HOLE Ø	gr.
		60	10	380	35	1.650
CH-19		W	T	A	HOLE Ø	gr.
		75	10	575	35	3.229
CH-20		W	T	A	HOLE Ø	gr.
		75	10	575	35	3.229
CH-21		W	T	A	HOLE Ø	gr.
		60	8	400	30	1.380
CH-22		W	T	A	HOLE Ø	gr.
		75	10	510	35	2.945

W= ANCHO T= ESPESOR A= ALTURA / W= WIDTH T= THICKNESS A= LENGTH











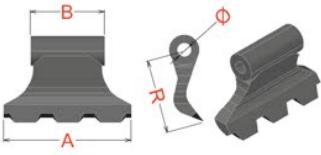

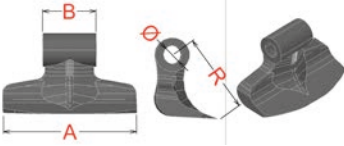





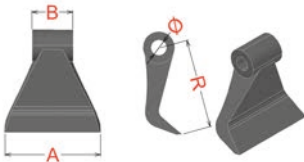

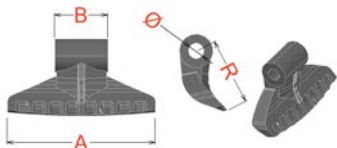

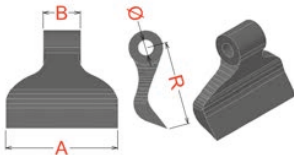

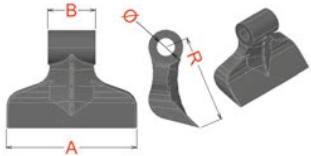



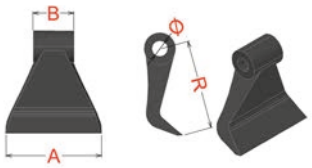

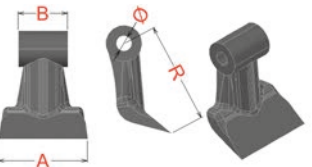

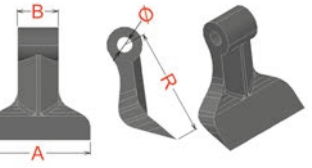

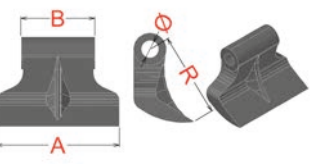

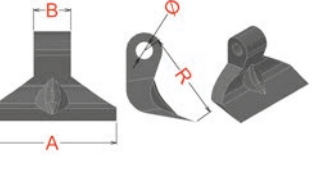
# MARTILLOS DE TRITURADORA

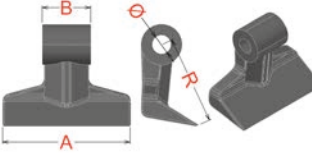

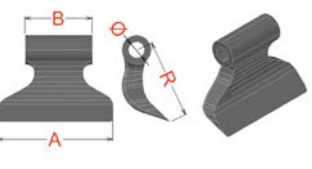

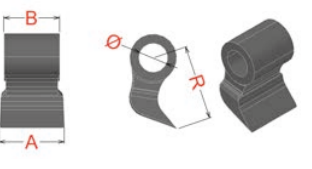

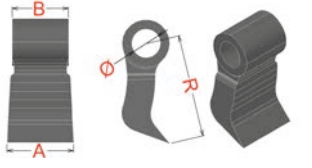



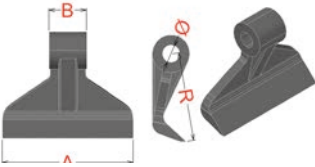

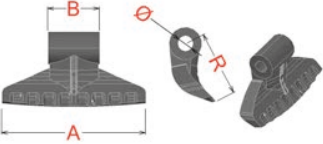

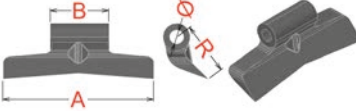

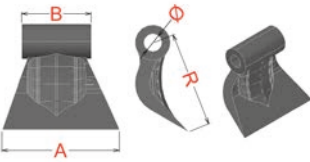
Crusher hammers / Marteaux de machine à broyer

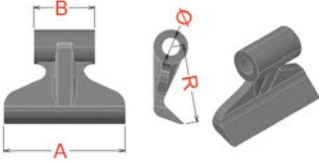

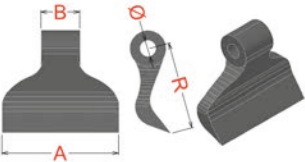

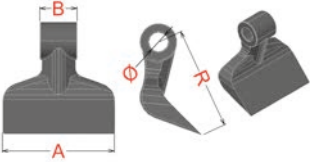

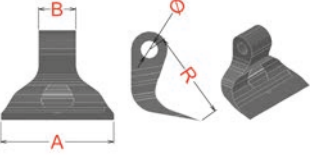



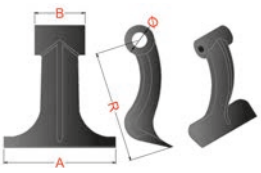

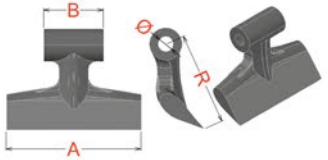

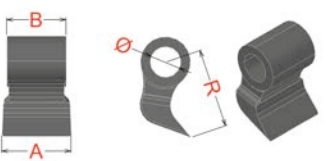

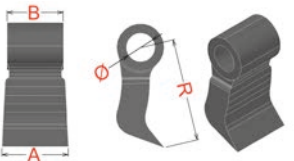

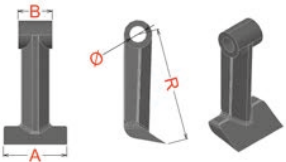

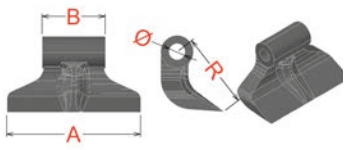

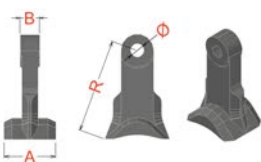

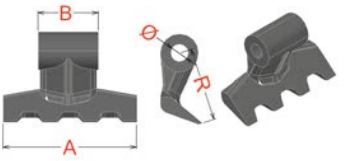



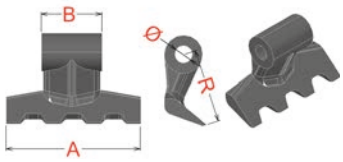



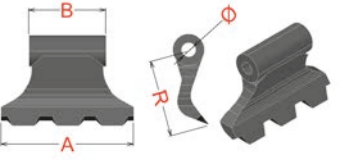

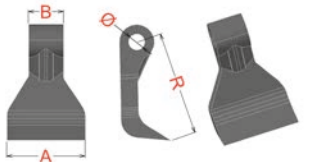

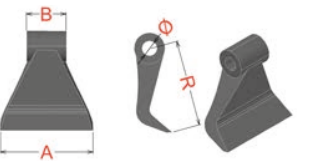

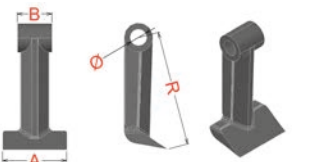

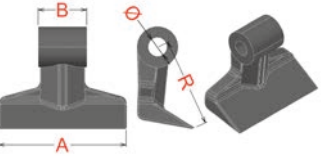



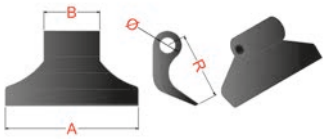

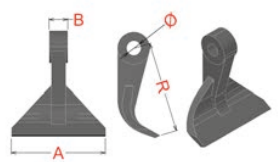

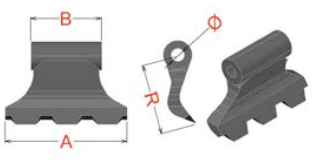

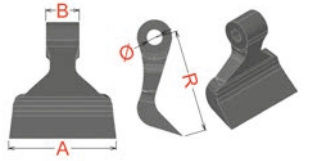

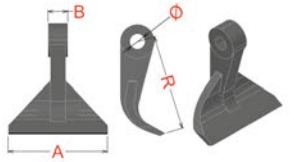
AGRATOR		DISEÑO/DESIGN		MEDIDAS / MEASUREMENTS (mm)				
REF. AN-2		A	B	R	HOLE Ø			
		155	90	110	20,5	1.800		
REF. AN-11		A	B	R	HOLE Ø			
		150	60	88	20,5	1.800		
REF. AN-24		A	B	R	HOLE Ø			
		83	51	180	28	2.130		
AGRIC		DISEÑO/DESIGN						
REF. AN-104		A	B	R	HOLE Ø			
		224	87	78	20,5	2.700		
AGRICOM		DISEÑO/DESIGN						
REF. AN-4		A	B	R	HOLE Ø			
		120	40	110	16,5 -18,5 20,5	1.350		
REF. AN-5		A	B	R	HOLE Ø			
		195	70	88	16,5 -20,5	2.300		
REF. AN-8		A	B	R	HOLE Ø			
		120	40	90	14,5 -16,5 20,5	1.150		
AGRIMASTER		DISEÑO/DESIGN						
REF. AN-10		A	B	R	HOLE Ø			
		145	55	100	16,5 -20,5	1.650		

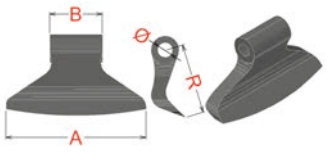
AGRIMASTER		DISEÑO/DESIGN		MEDIDAS / MEASUREMENTS (mm)				
REF. AN-33		A	B	R	HOLE Ø			
		85	40	95	14,5 -16,5 20,5	700		
REF. AN-39		A	B	R	HOLE Ø			
		85	47	97	14,5	650		
REF. AN-64		A	B	R	HOLE Ø			
		100	39	103	14,5 -20,5	700		
BELAFER		DISEÑO/DESIGN						
REF. BELAFER		A	B	R	HOLE Ø			
		150	90	108	20,5	2.830		
BERTI		DISEÑO/DESIGN						
REF. AN-6		A	B	R	HOLE Ø			
		137	40	95	16,5 -18,5 20,5	1.570		
REF. AN-29		A	B	R	HOLE Ø			
		137	52	95	19,5	1.850		
REF. AN-31		A	B	R	HOLE Ø			
		136	85	100	20,5	2.300		
REF. AN-102		A	B	R	HOLE Ø			
		70	60	80	30,5	1.700		
REF. AN-103		A	B	R	HOLE Ø			
		70	60	110	36	2.400		

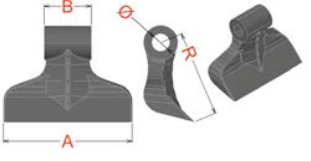

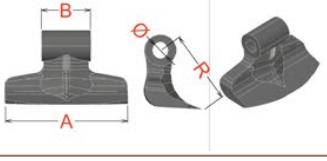

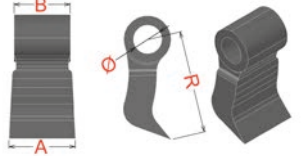





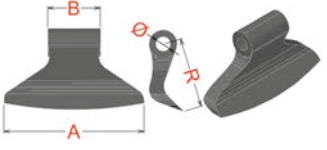
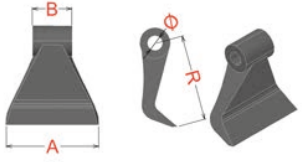

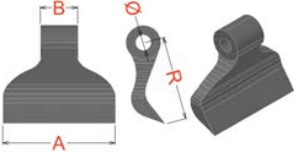
BERTI LIGERO DISEÑO/DESIGN		MEDIDAS / MEASUREMENTS (mm)				
REF. AN-30		A	B	R	HOLE Ø	
		140	40	95	16,5 -18,5	1.150
CANCELA						
REF. AN-5		A	B	R	HOLE Ø	
		195	70	88	16,5 -20,5	2.300
REF. AN-104		A	B	R	HOLE Ø	
		224	87	78	20,5	2.700
DRAGONE						
REF. AN-36		A	B	R	HOLE Ø	
		100	74	100	16,5 -18,5	1.450
REF. AN-95		A	B	R	HOLE Ø	
		156	70	90	16,5 -20,5	1.800
ENGUIX						
REF. AN-8		A	B	R	HOLE Ø	
		120	40	90	14,5 -16,5 20,5	1.150
EUROCLASS EMELENFER						
REF. AN-84		A	B	R	HOLE Ø	
		120	40	110	20,5	1.350
REF. AN-88		A	B	R	HOLE Ø	
		120	40	90	20,5	1.150

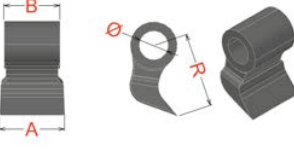
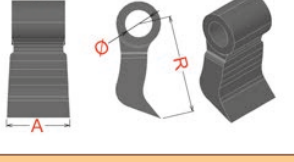





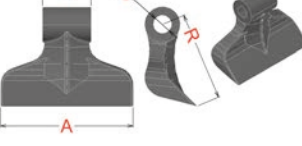



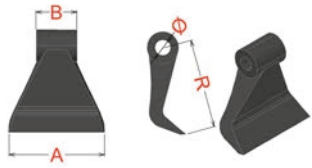

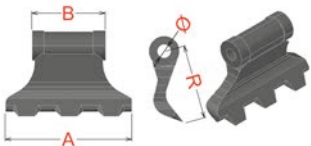

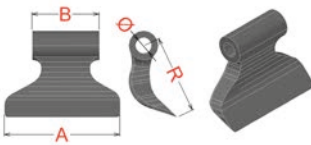

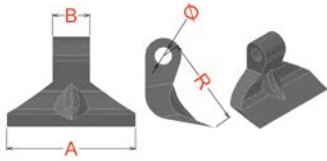

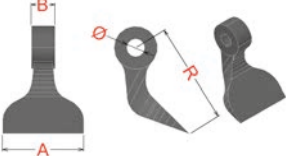
FACMA		DISEÑO/DESIGN		MEDIDAS / MEASUREMENTS (mm)				
REF. AN-45		A	B	R	HOLE Ø			
		162	72	157	20,5-22,5	2.750		
REF. AN-46		A	B	R	HOLE Ø			
		165	73	114	18,5 -22,5	1.750		
FAE		DISEÑO/DESIGN		MEDIDAS / MEASUREMENTS (mm)				
REF. AN-102		A	B	R	HOLE Ø			
		70	60	80	30	1.700		
REF. AN-103		A	B	R	HOLE Ø			
		70	60	110	36	2.400		
FALC		DISEÑO/DESIGN		MEDIDAS / MEASUREMENTS (mm)				
REF. AN-34		A	B	R	HOLE Ø			
		101	54	180	25,5	2.200		
FERNANDEZ		DISEÑO/DESIGN		MEDIDAS / MEASUREMENTS (mm)				
REF. AN-105		A	B	R	HOLE Ø			
		170	80	95	20,5	2.600		
FERRI		DISEÑO/DESIGN		MEDIDAS / MEASUREMENTS (mm)				
REF. AN-70		A	B	R	HOLE Ø			
		64	24	113	16,5	750		
FISHER		DISEÑO/DESIGN		MEDIDAS / MEASUREMENTS (mm)				
REF. AN-3		A	B	R	HOLE Ø			
		155	85	85	20,5	1.500		

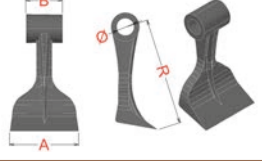
FREI		DISEÑO/DESIGN		MEDIDAS / MEASUREMENTS (mm)				
REF. AN-3		A	B	R	HOLE Ø			
		155	85	85	20,5	1.500		
GEO		DISEÑO/DESIGN		MEDIDAS / MEASUREMENTS (mm)				
REF. AN-35		A	B	R	HOLE Ø			
		80	44	82	13,5	420		
JONUES		DISEÑO/DESIGN		MEDIDAS / MEASUREMENTS (mm)				
REF. AN-2		A	B	R	HOLE Ø			
		155	90	110	20,5	1.800		
LAGARDE		DISEÑO/DESIGN		MEDIDAS / MEASUREMENTS (mm)				
REF. AN-9		A	B	R	HOLE Ø			
		90	40	120	14,5 -16,5	1.500		
MALETTI		DISEÑO/DESIGN		MEDIDAS / MEASUREMENTS (mm)				
REF. AN-4		A	B	R	HOLE Ø			
		120	40	110	16,5 -18,5 20,5	1.350		
MASCHIO		DISEÑO/DESIGN		MEDIDAS / MEASUREMENTS (mm)				
REF. AN-34		A	B	R	HOLE Ø			
		101	54	180	25,5	2.200		
REF. AN-85		A	B	R	HOLE Ø			
		150	60	88	20,5	1.200		

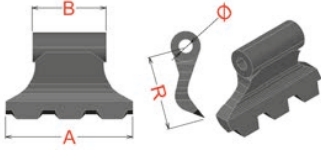
MILA		DISEÑO/DESIGN		MEDIDAS / MEASUREMENTS (mm)				
REF. AN-230		A	B	R	HOLE Ø			
		190	80	95	23		2.000	
MURATORI		DISEÑO/DESIGN						
REF. AN-7		A	B	R	HOLE Ø			
		110	22	105	16,5 -20,5		700	
NOBILI		DISEÑO/DESIGN						
REF. AN-2		A	B	R	HOLE Ø			
		155	90	110	20,5		1.800	
REF. AN-43		A	B	R	HOLE Ø			
		115	36	110	16,5		1.200	
PERFET		DISEÑO/DESIGN						
REF. AN-7		A	B	R	HOLE Ø			
		110	22	105	16,5 -20,5		700	
REF. AN-16		A	B	R	HOLE Ø			
		200	75	100	20,5		2.100	
PICURSA		DISEÑO/DESIGN						
REF. AN-10		A	B	R	HOLE Ø			
		145	55	100	16,5 -20,5		1.650	
REF. AN-11		A	B	R	HOLE Ø			
		150	60	88	20,5		1.800	
REF. AN-103		A	B	R	HOLE Ø			
		70	60	110	36		2.400	

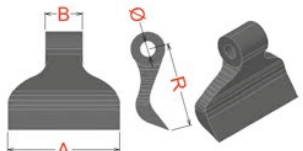

ROSATELLO		DISEÑO/DESIGN		MEDIDAS / MEASUREMENTS (mm)				
REF. AN-16		A	B	R	HOLE Ø			
		200	75	100	20,5		2.100	
SEPPI		DISEÑO/DESIGN						
REF. AN-4		A	B	R	HOLE Ø			
		120	40	110	16,5 -18,5 20,5		1.350	
REF. AN-8		A	B	R	HOLE Ø			
		120	40	90	14,5 -16,5 20,5		1.150	
REF. AN-102		A	B	R	HOLE Ø			
		70	60	80	30,5		1.700	
REF. AN-103		A	B	R	HOLE Ø			
		70	60	110	36		2.400	
SERRAT		DISEÑO/DESIGN						
REF. AN-205		A	B	R	HOLE Ø			
		123	80	106	20,5		2.200	
SERRAT FORESTAL		DISEÑO/DESIGN						
REF. AN-350		A	B	R	HOLE Ø			
		123	80	106	35		2.720	
SICMA		DISEÑO/DESIGN						
REF. AN-10		A	B	R	HOLE Ø			
		145	55	100	16,5 -20,5		1.650	

SICMA		DISEÑO/DESIGN		MEDIDAS / MEASUREMENTS (mm)				
REF. AN-33		A	B	R	HOLE Ø			
		85	40	95	14,5 -16,5 20,5	700		
TORTELLA		DISEÑO/DESIGN						
REF. AN-41		A	B	R	HOLE Ø			
		165	96	113	22,5	2.000		
REF. AN-42		A	B	R	HOLE Ø			
		165	96	113	22,5	2.300		
VIGOLO		DISEÑO/DESIGN						
REF. AN-6		A	B	R	HOLE Ø			
		137	40	95	16,5 -18,5 20,5	1.570		
REF. AN-32		A	B	R	HOLE Ø			
		75	22	94	16,5	700		
REF. AN-44		A	B	R	HOLE Ø			
		105	56	164	26	1.650		
WILLIBALD		DISEÑO/DESIGN						
REF. AN-2		A	B	R	HOLE Ø			
		155	90	110	20,5	1.800		
ZANON		DISEÑO/DESIGN						
REF. AN-8		A	B	R	HOLE Ø			
		120	40	90	14,5 -16,5 20,5	1.150		
REF. AN-33		A	B	R	HOLE Ø			
		85	40	95	14,5 -16,5 20,5	700		











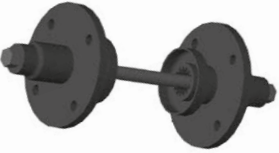



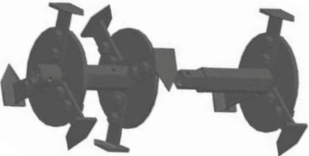
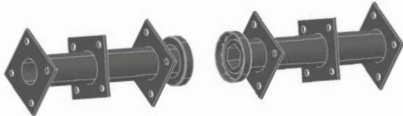

# FRESAS PARA MOTOAZADAS Y MOTOCULTORES

Tillage implements for motor hoes and walking tractors

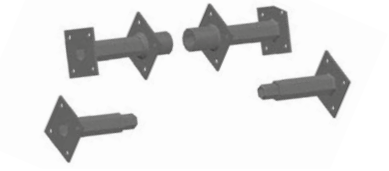
Fraises pour motobineuses et motoculteurs

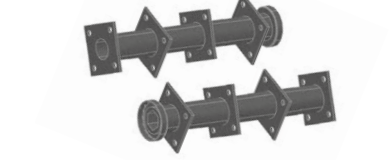

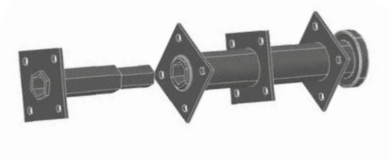
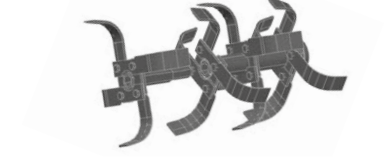
REF.	DISEÑO/DESIGN	MODELO/MODEL
<b>1X4 PARA CORTAHIERBAS</b>		PARA M-5 Y GL-4
<b>CORTAHIERBAS GL-4</b>		ADAPTABLE A CUALQUIER MODELO DE MOTOAZADA Y MOTOCULTOR
<b>CORTAHIERBAS M-5</b>		ADAPTABLE A CUALQUIER MODELO DE MOTOAZADA Y MOTOCULTOR
<b>2X4 FIJO S/MONTAR</b>		VARIOS MODELOS DE MAQUINA
<b>2X4 FIJO CON CUCHILLAS</b>		VARIOS MODELOS DE MAQUINA
<b>3X3 FIJO CON PICAZAS</b>		VARIOS MODELOS DE MAQUINA
<b>3X3 2 EJES CON PICAZAS</b>		VARIOS MODELOS DE MAQUINA
<b>3X4 FIJO S/MONTAR</b>		VARIOS MODELOS DE MAQUINA
<b>3X4 FIJO CON CUCHILLAS</b>		VARIOS MODELOS DE MAQUINA
<b>3X4 FIJO CON GANCHOS</b>		VARIOS MODELOS DE MAQUINA

REF.	DISEÑO/DESIGN	MODELO/MODEL
<b>3X4 2 EJES S/MONTAR</b>		VARIOS MODELOS DE MAQUINA
<b>3X4 2 EJES CON CUCHILLAS</b>		VARIOS MODELOS DE MAQUINA
<b>4X4 2 EJES CON GANCHOS</b>		VARIOS MODELOS DE MAQUINA
<b>4X4 FIJO S/MONTAR</b>		VARIOS MODELOS DE MAQUINA
<b>4X4 FIJO CON CUCHILLAS</b>		VARIOS MODELOS DE MAQUINA
<b>4X4 2 EJES S/MONTAR</b>		VARIOS MODELOS DE MAQUINA
<b>4X4 2 EJES CON CUCHILLAS</b>		VARIOS MODELOS DE MAQUINA
<b>4X4 3 EJES S/MONTAR</b>		VARIOS MODELOS DE MAQUINA
<b>4X4 3 EJES CON CUCHILLAS</b>		VARIOS MODELOS DE MAQUINA







# ACCESORIOS PARA MOTOAZADAS Y MOTOCULTORES



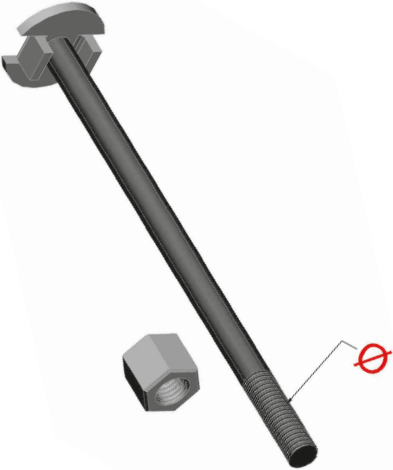
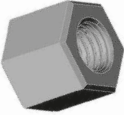

Implement accessories for motor hoes and walking tractors

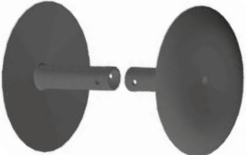
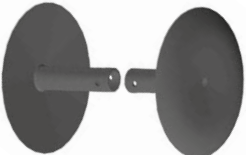
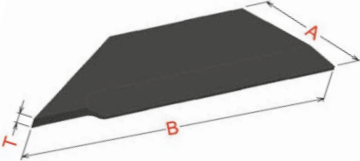

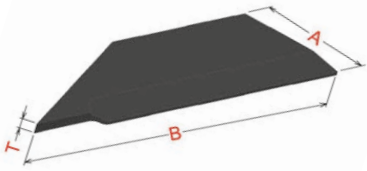
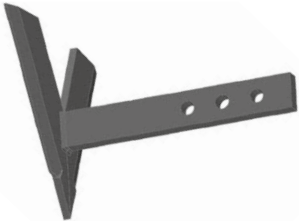
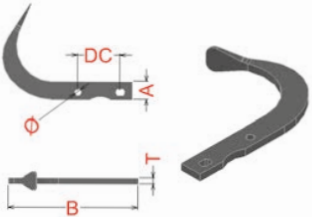
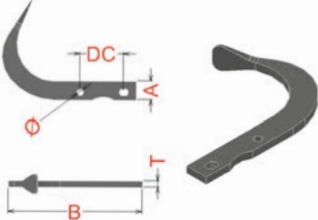
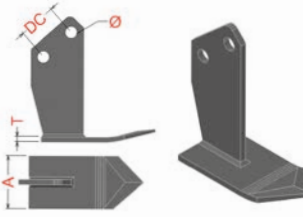
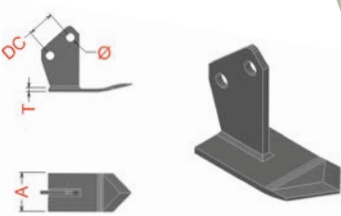
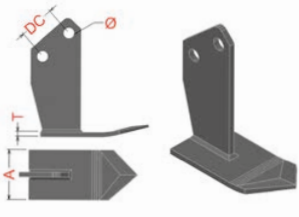
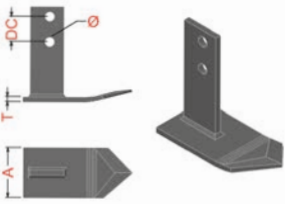

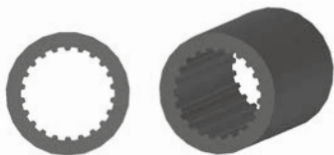
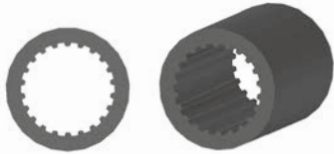
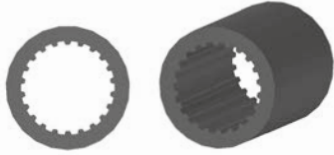
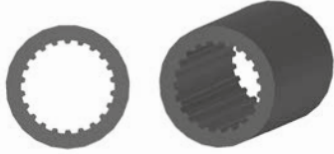

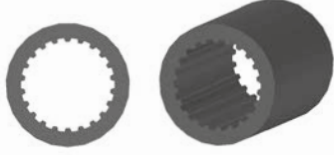

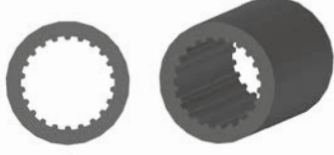
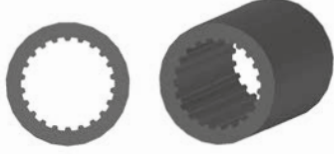

Accessoires pour motobineuses et motoculteurs











REF.	DISEÑO/DESIGN	MEDIDAS / MEASUREMENTS (mm)			
<b>EJES PARA FRESAS</b>		gr.			
		10	1.025		
		gr.			
		12	1.050		
		gr.			
		14	1.080		
		gr.			
		16	1.120		
<b>TUERCAS</b>		gr.			
		14	1.170		
<b>ARANDELAS DE REBAJE/TOPE</b>		gr.			
		—	0,020		
<b>SUPLEMENTO DE FRESA</b>		gr.			
		VARIOS MODELOS	1.000		
<b>JUEGO PLATOS PROTECCION</b>		gr.			
		200	1.130		
<b>JUEGO PLATOS PROTECCION</b>		gr.			
		250	1.500		
<b>ALETA N° 10-B</b>		A	T	B	gr.
		45	5	180	0,230

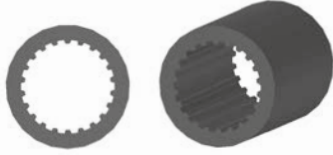
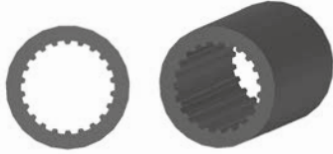

REF.	DISEÑO/DESIGN	MEDIDAS / MEASUREMENTS (mm)					
		A	T	B	gr.		
<b>ALETA Nº. 12-B</b>		60	6	245	0,510		
<b>PATIN CON BASTAGO PLETINA 35X12</b>		SOLDADO CON ALETA 10-B SOLDADO CON ALETA 12-B			1.640		
<b>GANCHO MOTOAZADA AGRIA 3.000</b>		30	200	10	70	10,5	0.580
<b>GANCHO MOTOAZADA AGRIA 7.000</b>		30	150	10	70	10,5	0,470
<b>PICAZA MOTOCULTOR 18 H.P.</b>		80	—	7	57	13,5	1.020
<b>PICAZA MOTOAZADA CORTA PASQUALI</b>		60	—	6	42	12,5	0,570
<b>PICAZA MOTOAZADA LARGA PASQUALI</b>		60	—	6	42	12,5	0,610
<b>PICAZA MOTOAZADA TALADRO JUNTO</b>		60	—	6	30	10,5	0,500

REF.	DISEÑO/DESIGN	BOQUILLAS / ACCESSORIES		
		HEXAGONAL (mm)	ESTRÍAS	gr.
<b>AGRIA 1.900 H.P.</b>		—	19	0,985
<b>AGRIA 3.000 602-604-660</b>		—	13	0,225
<b>AGRIA 7.000 GASOIL</b>		—	18	0,710
<b>AGRIA 7.711 14 H.P.</b>		—	16	0,345
<b>BRONCO GRANDE</b>		—	6	0,505
<b>CONDOR Y AGRIA 7.713</b>		—	16	0,295
<b>CAVASOLA GRANDE</b>		—	8	0,650
<b>GIRMET GRANDE ANTIGUA</b>		—	8	0,655
<b>GIRMET MODERNO</b>		—	17	0,720
<b>LANDER ESTRIADO</b>		—	18	0,540

REF.	DISEÑO/DESIGN	BOQUILLAS / ACCESSORIES		
		HEXAGONAL (mm)	ESTRÍAS	
MACAPER		—	8	0,510
MACAPER		—	18	0,610
MOVICAM M-4 Y CONESA		—	8	0,605
MOVICAM PEQUEÑO TG		—	15	0,300
MOVICAM M-5		—	18	0,540
PASQUALI ANTIGUA		—	6	0,460
PASQUALI		—	8	0,460
PEYMA		—	14	0,345
TRUSS M-6 Y M-4		—	8	0,350
TRUSS M-8		—	10	0,365

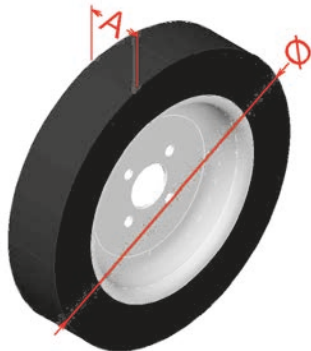

REF.	DISEÑO/DESIGN	BOQUILLAS / ACCESSORIES		
		HEXAGONAL (mm)	ESTRÍAS	gr.
TRUSS M-8		HEXAGONAL (mm)	ESTRÍAS	gr.
		—	15	0,300
TRUSS 3598		HEXAGONAL (mm)	ESTRÍAS	gr.
		—	18	0,540
AGRIA 7.000 HEXAGONAL DE 27		HEXAGONAL (mm)	ESTRÍAS	gr.
		27	—	0,610
ALFA HEXAGONAL DE 26 Y HONDA 600		HEXAGONAL (mm)	ESTRÍAS	gr.
		26	—	0,545
VOLPINO HEXAGONAL DE 20		HEXAGONAL (mm)	ESTRÍAS	gr.
		20	—	0,232
HONDA HEXAGONAL DE 23		HEXAGONAL (mm)	ESTRÍAS	gr.
		23	—	0,352
LANDER FOT HEXAGONAL 27		HEXAGONAL (mm)	ESTRÍAS	gr.
		27	—	0,554
VOLPINO HEXAGONAL DE 28		HEXAGONAL (mm)	ESTRÍAS	gr.
		28	—	0,424
SIMPLE HEXAGONAL DE 30		HEXAGONAL (mm)	ESTRÍAS	gr.
		30	—	0,702
BARBIERI HEXAGONAL DE 35		HEXAGONAL (mm)	ESTRÍAS	gr.
		35	—	0,765

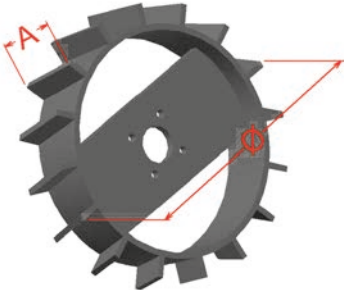
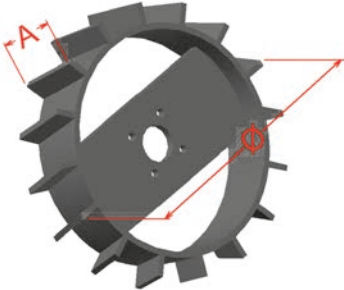
REF.	DISEÑO/DESIGN	RUEDAS NEUMATICAS / AGRICULTURE TIRES	
RUEDAS NEUMATICAS		Ø x A (mm)	gr.
		350 X 8 LISA	3.020
		Ø x A (mm)	gr.
		400 X 8 LISA	4.320
		Ø x A (mm)	gr.
RUEDAS NEUMATICAS		400 X 8	4.330
		Ø x A (mm)	gr.
		400 X 10	6.410
		Ø x A (mm)	gr.
		500 X 10	8.010
		Ø x A (mm)	gr.
		500 X 12	12.600
Ø x A (mm)	gr.		
650/80 X 12	11.700		
REF.	DISEÑO/DESIGN	RUEDAS METALICAS / IRON WHEELS	
JUEGO DE RUEDAS METALICAS		Ø x A (mm)	gr.
		250 X 50	3.150
		Ø x A (mm)	gr.
JUEGO DE RUEDAS METALICAS		330 X 100	6.080
		Ø x A (mm)	gr.
		350 X 60	4.260
		Ø x A (mm)	gr.
		400 x 100	8.220
		Ø x A (mm)	gr.
		500 x 120	12.640

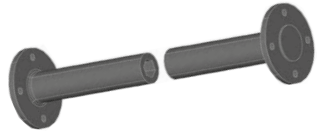
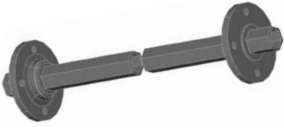
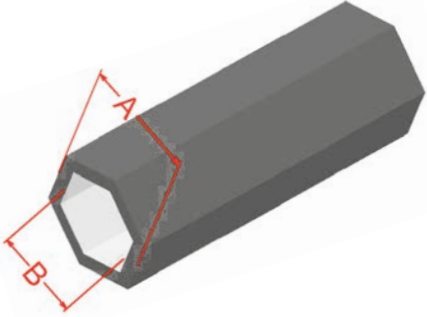
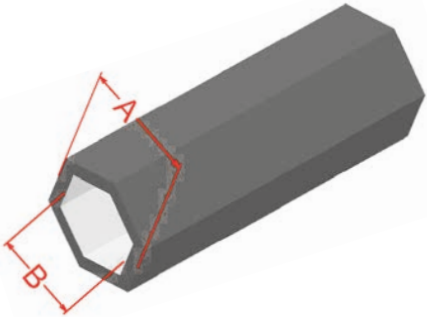
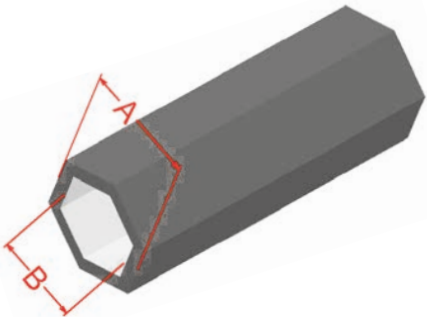
REF.	DISEÑO/DESIGN	BUJES / ACCESORIES	
BUJE FIJO PARA RUEDAS NEUMATICAS Y METALICAS		gr.	
		_____	5.320
BUJE REGULABLE PARA RUEDAS NEUMATICAS Y METALICAS		gr.	
		_____	8.120
REF.	DISEÑO/DESIGN	TUBO HEXAGONAL / HEXAGON TUBE	
TUBO HEXAGONAL		A X B (mm)	gr. x metro
		20 X 14	1.350
		A X B (mm)	gr. x metro
		26 x 18	2.400
		A X B (mm)	gr. x metro
TUBO HEXAGONAL		27 x 19	2.286
		A X B (mm)	gr. x metro
		27 x 23	1.250
		A X B (mm)	gr. x metro
		28 x 20	2.472
TUBO HEXAGONAL		A X B (mm)	gr. x metro
		28 x 36	3.330
		A X B (mm)	gr. x metro
		30,5 x 23	2.630
		A X B (mm)	gr. x metro
		35 x 27	3.250
		A X B (mm)	gr. x metro
		42 x 36	3.068

# REJAS PARA CULTIVADORES

Cultivator parts / Grilles pour cultivateur

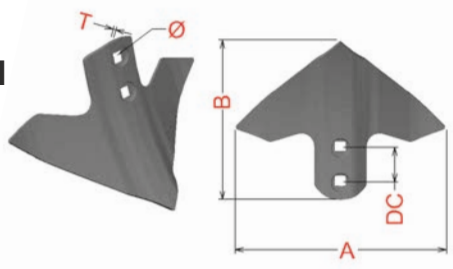
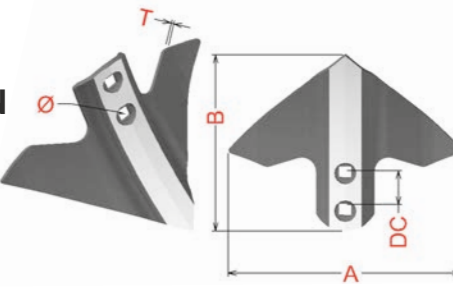
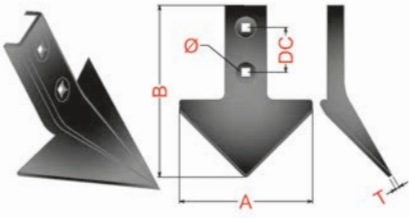
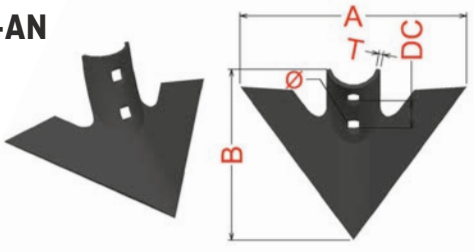
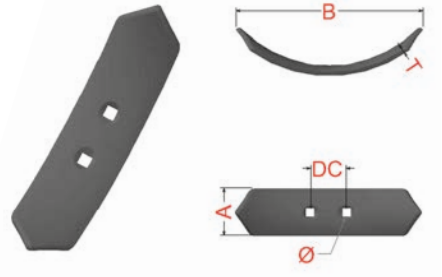
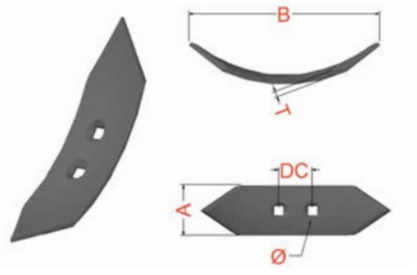

REF.	DISEÑO/DESIGN	MEDIDAS / MEASUREMENTS (mm)					
		A	B	T	D.C.	HOLE $\emptyset$	gr.
<b>513-A</b> AN S/N		280	220	6	45	12,5	1.402
<b>513-A</b> AN C/N		274	216	7	45	12,5	1.668
<b>C-04-AN</b>		133	172	4	45	10,5	408
<b>C-05-AN</b>		200	180	5	45	10,5	576
<b>215-AN</b>		55	235	6	45	10,5	550
<b>535-A</b> AN		65	255	8	45	12,5	910

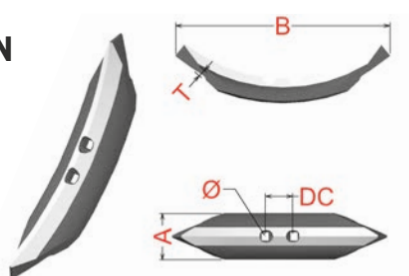
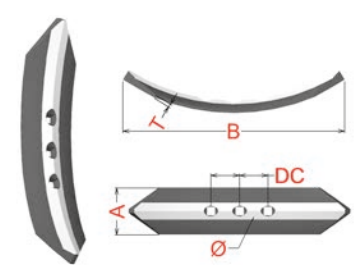
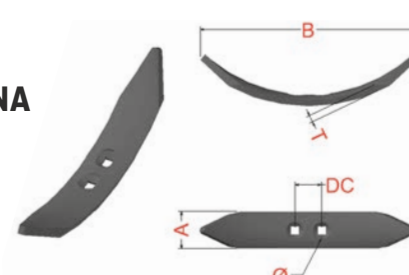
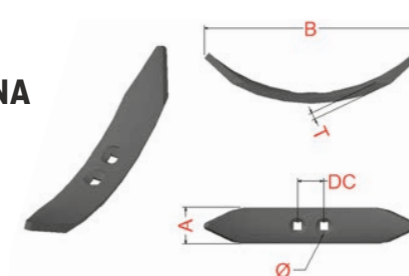
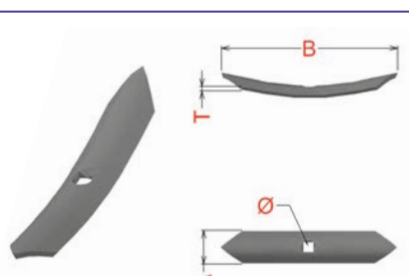
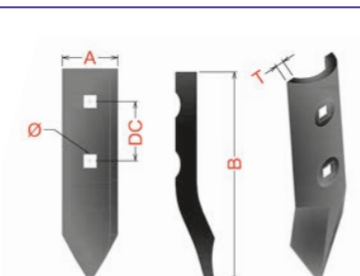
REF.	DISEÑO/DESIGN	MEDIDAS / MEASUREMENTS (mm)					
		A	B	T	D.C.	HOLE Ø	gr
<b>535-B AN C/N 2T.</b>		75	320	9	45	12,5	1.780
<b>535-B AN C/N 3T.</b>		75	320	9	45	12,5	1.780
<b>REJA CATALANA</b>		65	380	12	45	12,5	1.875
<b>REJA CATALANA</b>		60	380	12	45	12,5	1.820
<b>R-6 K01 A/N S/N</b>		40	190	5	1 TALADRO	10,5	260
<b>R-7 08-AN UNA PUNTA</b>		45	165	8	45	10,5	355

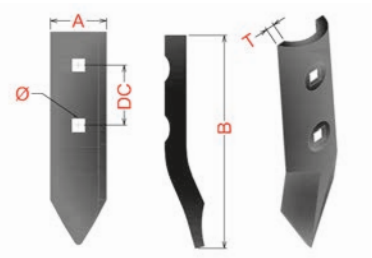
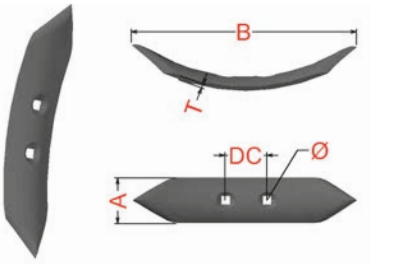
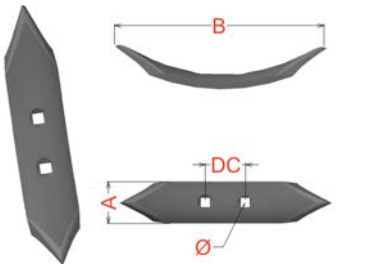
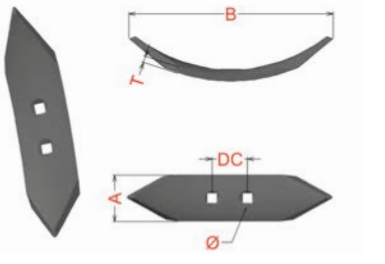
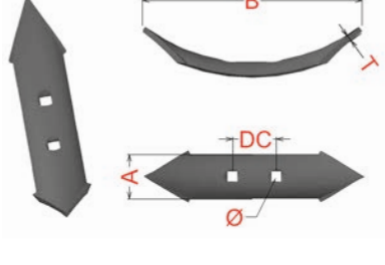
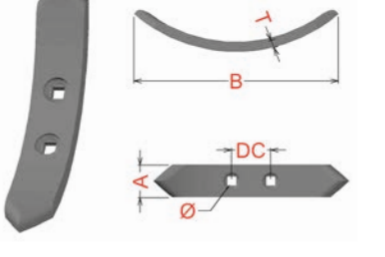

REF.	DISEÑO/DESIGN	MEDIDAS / MEASUREMENTS (mm)					
		A	B	T	D.C.	HOLE Ø	gr.
<b>R-8-AN</b> UNA PUNTA		45	160	8	45	9,5	340
<b>R-9-AN</b>		45	242	8	45	9,5	530
<b>R-10-AN</b>		45	235	8	45	10,5	535
<b>R-11-AN</b>		60	260	8	45	12,5	890
<b>R-12-AN</b>		50	240	6	45	10,5	525
<b>R-20-AN</b>		50	400	20	60	13	2.575

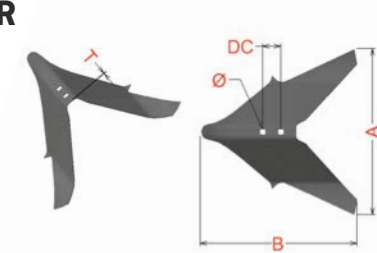
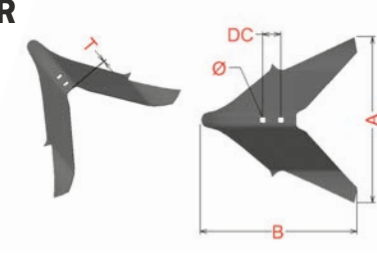
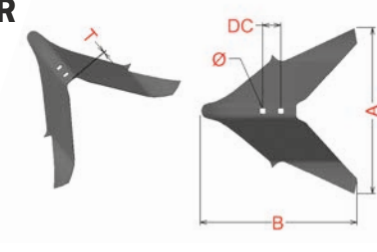
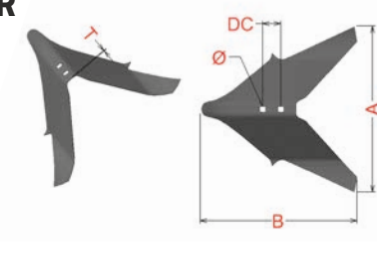
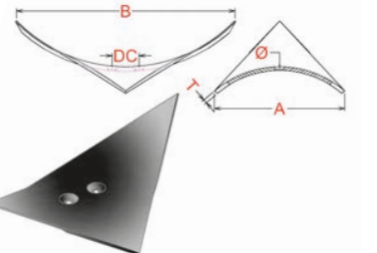
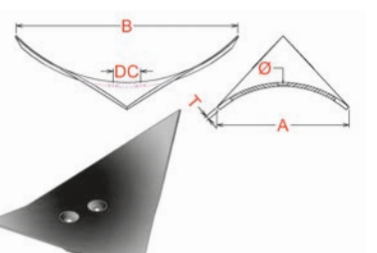
REF.	DISEÑO/DESIGN	MEDIDAS / MEASUREMENTS (mm)					
		A	B	T	D.C.	HOLE Ø	g
<b>ASURCADOR Nº. 1</b>		430	420	5	45	13	3.804
<b>ASURCADOR Nº. 2</b>		350	370	5	45	13	2.800
<b>ASURCADOR Nº. 3</b>		255	300	5	45	13	1.700
<b>ASURCADOR Nº. 4</b>		215	275	5	45	13	1.465
<b>ROMBO PEQUEÑO</b>		160	360	10	45	13	2.710
<b>ROMBO GRANDE</b>		200	360	8	45	13	2.960

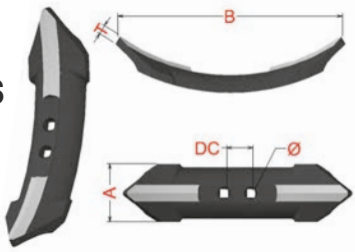
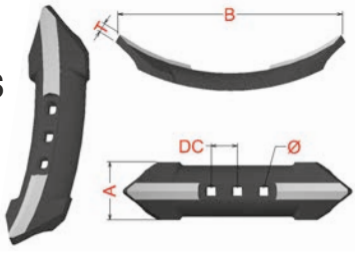
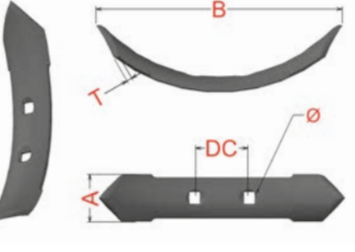
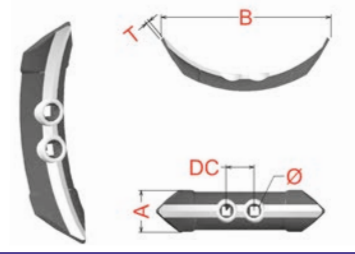
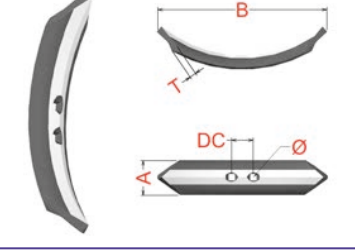
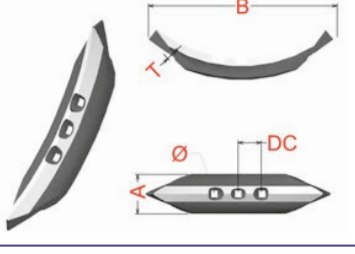
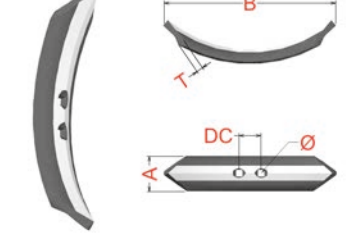
REF.	DISEÑO/DESIGN	MEDIDAS / MEASUREMENTS (mm)					
		A	B	T	D.C.	HOLE Ø	gr.
<b>LP-35-B 2 TALADROS</b>		80	330	10	45	10,5	1.935
<b>LP-35-B 3 TALADROS</b>		80	340	10	45	10,5	1.925
<b>R- 1S/N</b>		50	237	6	45	10,5	500
<b>R- 2C/N</b>		60	270	8	45	12,5	1.100
<b>R-3 2-A C/N</b>		75	335	10	45	12,5	2.030
<b>R-3 3-A C/N</b>		75	335	10	45	12,5	2.010
<b>R-3 2-A C/N NEW</b>		75	335	10	45	12,5	2.030

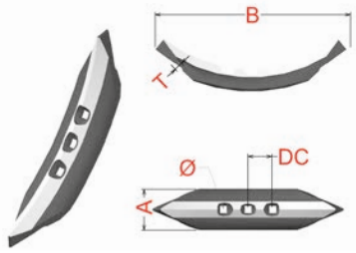
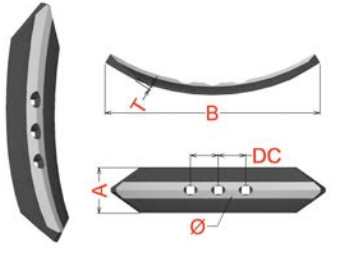
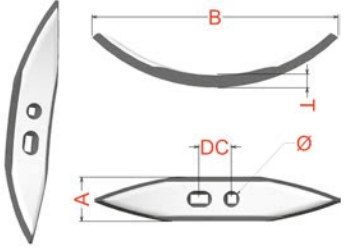
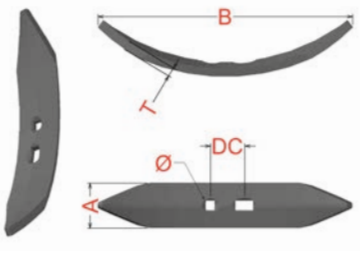
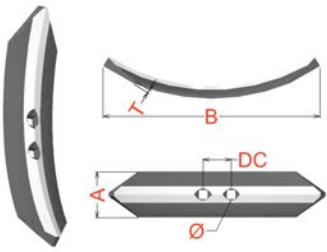
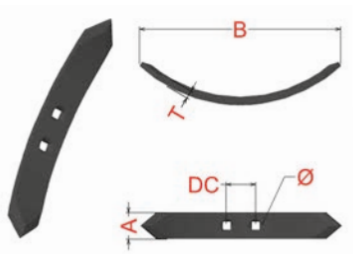
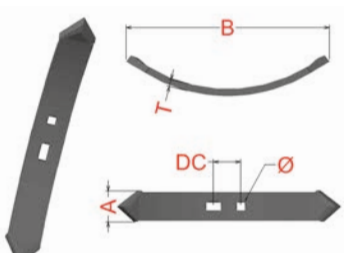
REF.	DISEÑO/DESIGN	MEDIDAS / MEASUREMENTS (mm)					
		A	B	T	D.C.	HOLE Ø	gr
<b>R-3 3-A C/N NEW</b>		75	335	10	45	12,5	2.010
<b>R-4 C/N</b>		82	390	12	45	12,5	3.030
<b>R-5 C/N</b>		70	400	13	45	12,5	2.250
<b>R-5 S/N</b>		68	397	13	45	12,5	2.150
<b>R-7 C/N</b>		66	320	14	45	12,5	2.250
<b>R-11</b>		40	305	12	45	12,5	1.150
<b>R-12</b>		55	410	15	45	12,5	2.550

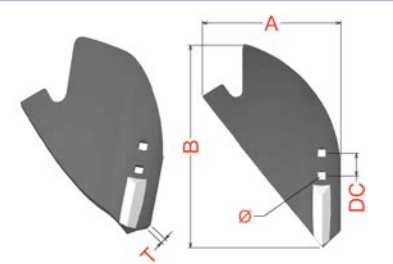
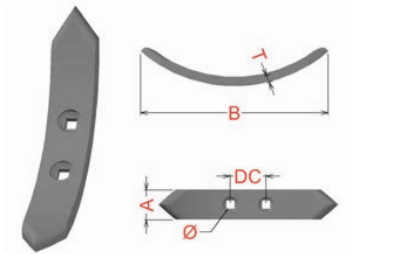
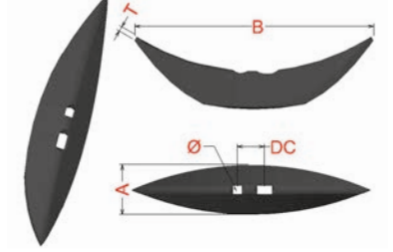
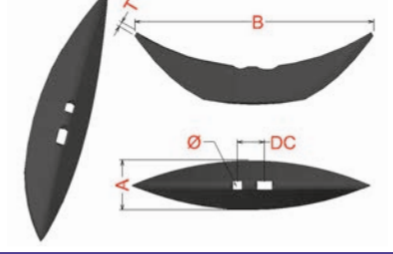
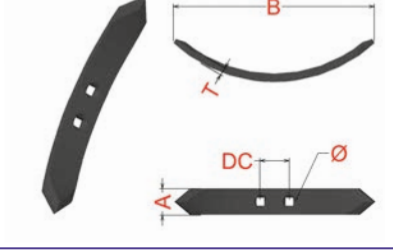
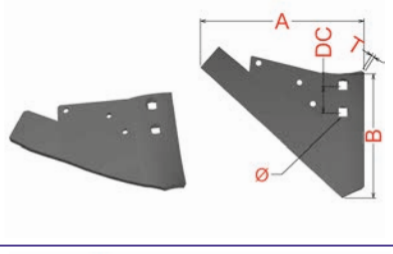
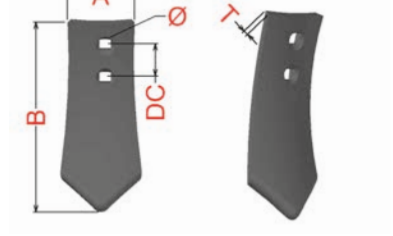
REF.	DISEÑO/DESIGN	MEDIDAS / MEASUREMENTS (mm)					
		A	B	T	D.C.	HOLE Ø	gr.
R-14		280	420	6	45	12,5	3.450
R-15		40	285	16	45	12,5	1.050
R-16		84	395	8	45	12,5	1.650
R-17		84	436	8	45	12,5	1.920
R-18		50	457	25	45	12,5	3.950
R-19		200	280	7	45	12,5	2.150
R-19 S		95	240	12	45	12,5	1.620

REF.	DISEÑO/DESIGN	MEDIDAS / MEASUREMENTS (mm)					
		A	B	T	D.C.	HOLE Ø	gr
R-20		200	330	6	40-70	8,5	2.220
R-21		230	380	6	40-70	8,5	3.050
R-22		40	215	4,5	45	12,5	395
R-23		60	270	8	45	12,5	940
R-24 2-A/3-A		70	340	10	45	12,5	1.600
R-30		47	228	7	45	12,5	600
R-31 2-A		72	410	20	45	12,5	3.430

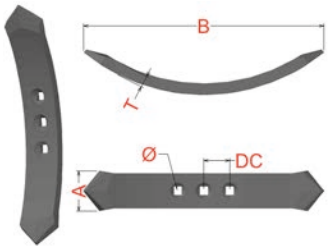
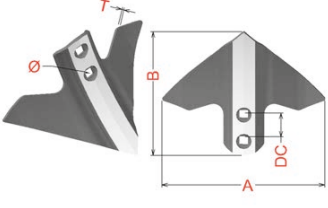
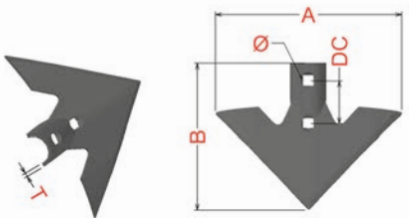
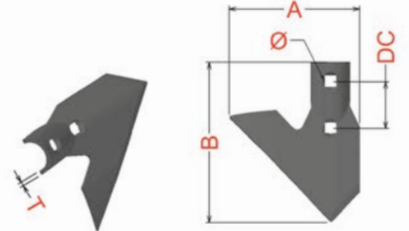
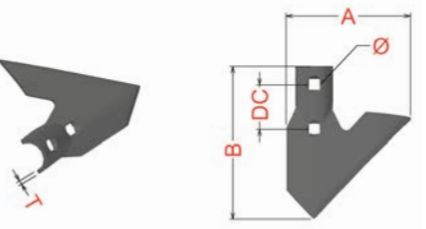
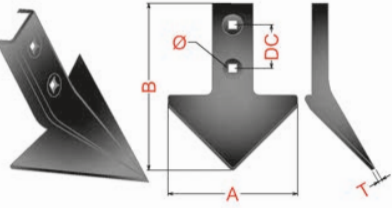
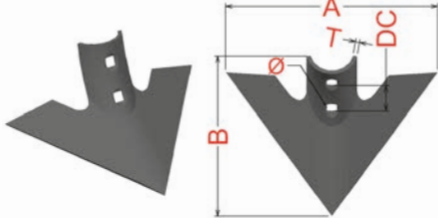

REF.	DISEÑO/DESIGN	MEDIDAS / MEASUREMENTS (mm)					
		A	B	T	D.C.	HOLE Ø	gr.
R-31 3-A		72	410	20	45	12,5	3.280
LP-13-A C/N		270	225	7	45	12,5	1.700
C-01		197	132	4	45	10,5	375
C-02		130	132	4	45	10,5	300
C-03		130	132	4	45	10,5	300
C-04		136	150	4,5	45	10,5	360
C-1		240	190	5	45	12,5	950

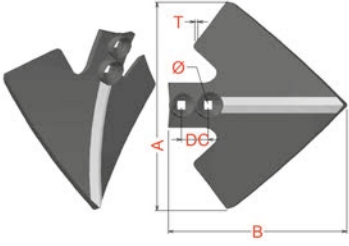
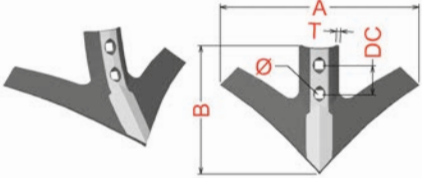
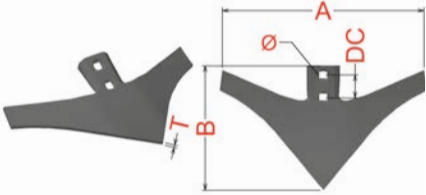
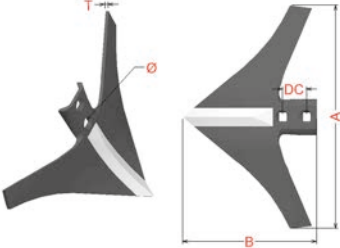
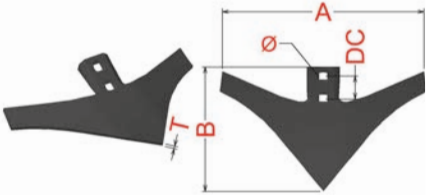
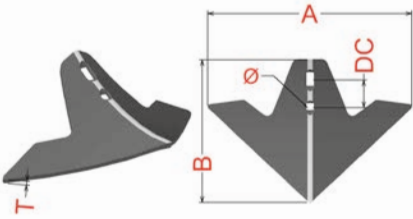
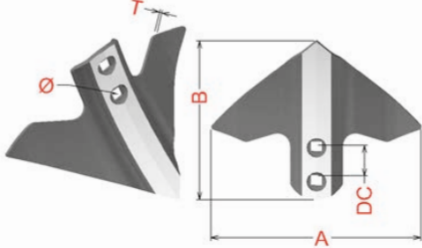
REF.	DISEÑO/DESIGN	MEDIDAS / MEASUREMENTS (mm)					
		A	B	T	D.C.	HOLE Ø	gr
<b>C-3</b> C/N		350	275	7	45	12,5	2.400
<b>C-4-A</b> C/N		410	240	7	45	12,5	2.230
<b>C-4-B</b> S/N		355	240	6	45	12,5	1.650
<b>C-4-B</b> C/N		345	240	6,5	45	12,5	1.985
<b>C-4-B</b> 8 S/N		355	240	8	45	12,5	2.150
<b>C-5</b> C/N		335	240	7	45	12,5	2.145
<b>C-6</b>		266	220	7	45	12,5	1.600

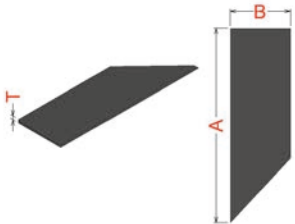
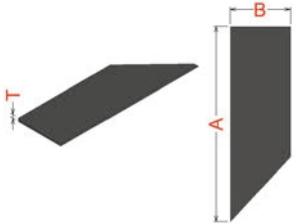
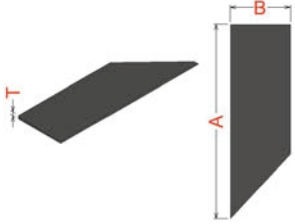
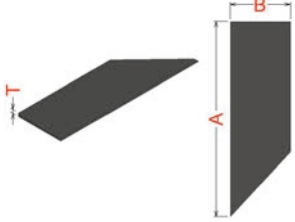
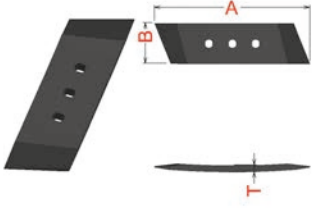
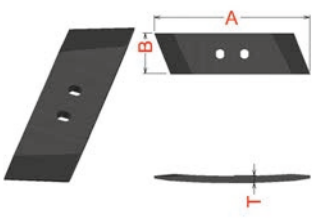
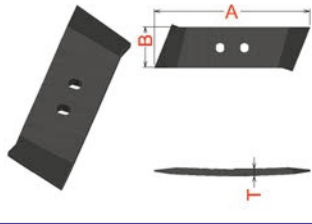
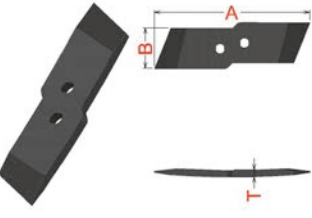
REF.	DISEÑO/DESIGN	MEDIDAS / MEASUREMENTS (mm)			
		A	B	T	gr
<b>R-328-12</b> S/TERMINADA		410	130	10	2.930
<b>R-328-13</b> S/TERMINADA		450	135	10	3.310
<b>R-328-14</b> S/TERMINADA		475	140	10	3.570
<b>R-328-16</b> S/TERMINADA		560	140	10	5.050
<b>R-355</b> CON TALADROS		305	70	14	1.800
<b>R-365</b> CON TALADROS		265	65	12	1.530
<b>R-375</b> CON TALADROS		264	76	13	1.480
<b>R-385</b> CON TALADROS		300	85	12	2.000

## **BRAZOS FORJADOS**

**Forged steel tines / Bras forgés**

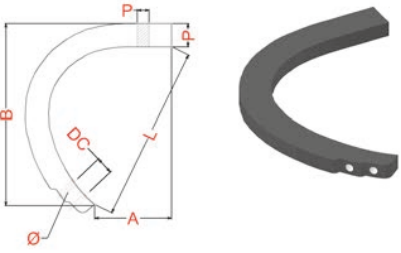
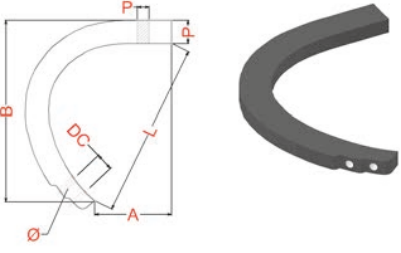
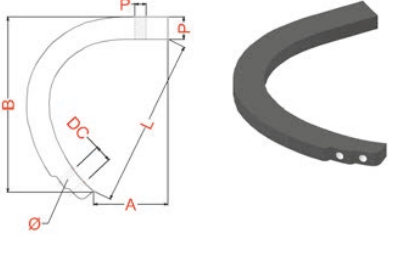
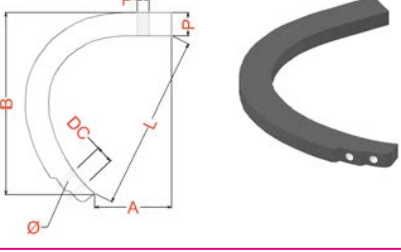
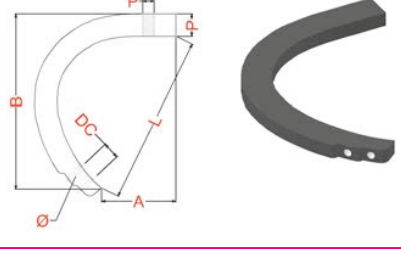
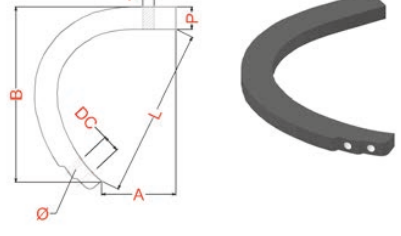

REF.	DISEÑO/DESIGN	MEDIDAS / MEASUREMENTS (mm)							
		A	B	L	C	P	HOLE $\emptyset$	D.C.	
<b>BRAZO N° 2</b>		168	381	371	—	50x25	13	45	5.760
<b>BRAZO N° 4</b>		197	463	449	—	60x25	13	45	8.320
<b>BRAZO N° 5</b>		278	504	524	—	60x25	13	45	9.200
<b>BRAZO N° 13</b>		197	463	449	—	60x30	13	45	9.910
<b>BRAZO N° 14</b>		278	504	524	—	60x30	13	45	11.070
<b>BRAZO N° 17</b>		150	480	437	—	70x30	13	45	12.000

REF.	DISEÑO/DESIGN	MEDIDAS / MEASUREMENTS (mm)							
		A	B	L	C	P	HOLE Ø	D.C.	gf
<b>BRAZO N° 18</b>		266	515	518	—	70x30	13	45	13.420
<b>BRAZO N° 39 VIÑEDO</b>		271	502	510	260	70x30	13	45	14.670
<b>BRAZO N° 40 VIÑEDO</b>		231	452	510	290	70x30	13	45	13.420
<b>BRAZO N° 41 VIÑEDO</b>		157	490	437	270	70x30	13	45	15.000
<b>BRAZO N° 50</b>		280	469	560	—	80x40	13	45	20.740
<b>CONJUNTO CHISEL / CHISEL ASSEMBLY</b>									
<b>MORDAZA BRAZO FORJADO</b>		F	P	A	B	C	D	gf	
		90x90	70x30	620	600	410	160	47.700	
		100x100	70x30	620	600	410	160	50.000	





## **DIENTES - BOTAS DE SUBSOLADOR**

Teeth - Subsoil spare parts

Dent - botte de sous-soleuse





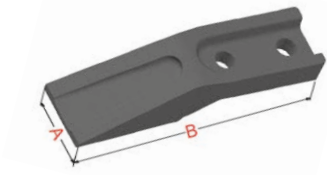
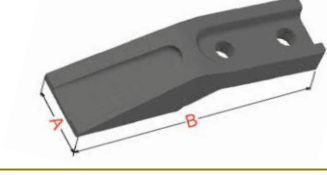
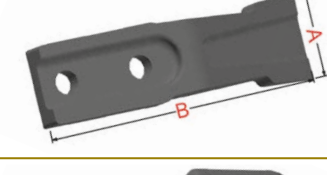
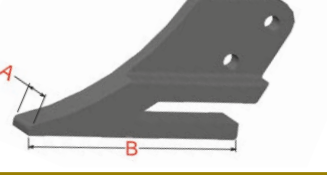

REF.	DISEÑO/DESIGN	MEDIDAS / MEASUREMENTS (mm)			
AN-1701 GRANDE		A	B	gr	
		65	170	2.050	
AN-1708 PEQUEÑO		A	B	gr	
		45	160	1.270	
TSJ-250 P TRASTELL		A	B	gr	
		30	210	2.730	
CP-39		A	B	gr	
		45	130	850	
CP-40		A	B	∅	gr
		45	160	—	1.270
CP-40 R		A	B	∅	gr
		45	160	—	1.400
CP-42 JYMPA		A	B	∅	gr
		50	140	35-40	1.525
CP - 52		A	B	∅	gr
		65	160	—	2.050
CP - 53		A	B	∅	gr
		—	—	35-40	1.980

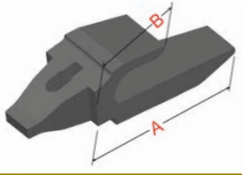
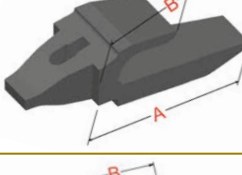
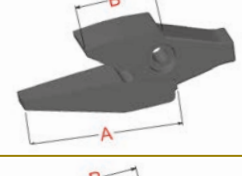
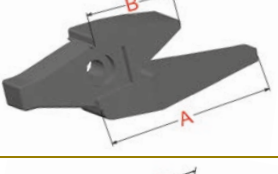
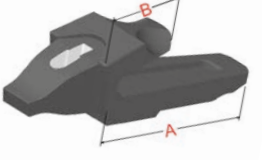
REF.	DISEÑO/DESIGN	MEDIDAS / MEASUREMENTS (mm)			
		A	B	∅	gr
CP-127		60	180	—	1.000
CP-174		60	210	—	1.650
CP-199		50	245	—	2.400
CP-200		55	265	—	5.350

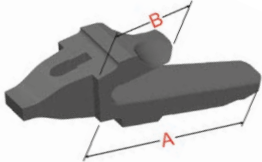
PORTADIENTES / TEETH ADAPTERS

REF.	DISEÑO/DESIGN	MEDIDAS / MEASUREMENTS (mm)				
		A	B	C	∅	gr
AN-GRANDE		170	80	25°	—	3.050
AN-PEQUEÑO		110	60	25°	—	1.560
TRASTELL		160	100	25°	—	4.150
CB-37		110	60	25°	—	1.560
CB-38		150	80	25°	—	2.200





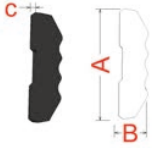
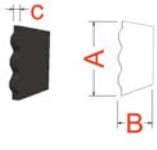
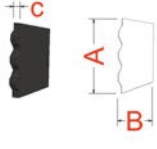
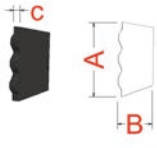

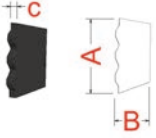
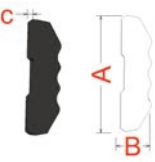
REF.	DISEÑO/DESIGN	MEDIDAS / MEASUREMENTS (mm)				
CB-50		A	B	C	∠	g
		170	80	25°	—	3.500
AM-35		A	B	C	∠	g
		—	—	—	35	4.100
AM-40		A	B	C	∠	g
		—	—	—	40	9.200
J-350 JYMPA		A	B	C	∠	g
		—	—	—	35	4.100
J-400 JYMPA		A	B	C	∠	g
		—	—	—	40	4.250



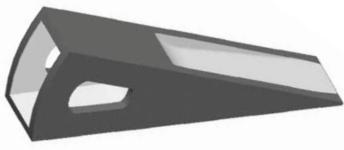

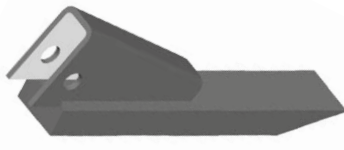

## SISTEMAS DE FIJACIÓN / FIXATION SYSTEMS

REF.	DISEÑO/DESIGN	MEDIDAS / MEASUREMENTS (mm)		
PASADOR GRANDE		A	B	C
		72	19	9
GOMACP-40		A	B	C
		44	22	14,5
GOMACP-42		A	B	C
		35	14	12
GOMACP-52		A	B	C
		44	22	14,5

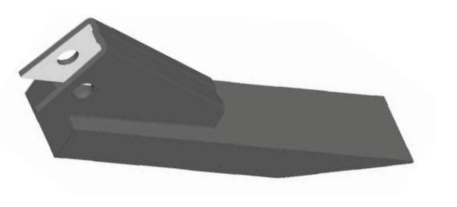
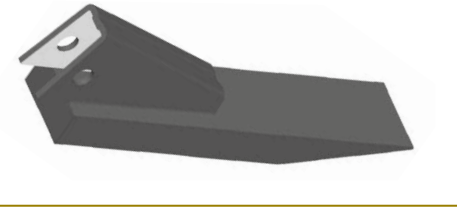
REF.	DISEÑO/DESIGN	MEDIDAS / MEASUREMENTS (mm)		
		A	B	C
<b>GOMACP-53</b>		44	22	12,5
<b>PASADOR PEQUEÑO</b>		60	13	6

BOTAS SUBSOLADOR / SUBSOIL SPARE PARTS

REF.	DISEÑO/DESIGN	MEDIDAS / MEASUREMENTS (mm)	
		∅	gr
<b>BOTA AN-181</b>		35	5.000
<b>BOTA AN YIMPA GRANDE (CAJERA SOLDADA + FORMON)</b>		40	5.920
<b>BOTA AN YIMPA PEQUEÑA (CAJERA SOLDADA + FORMON)</b>		35	5.640
<b>BOTA LONGA L-40</b>		40	9.330
<b>BOTA LONGA L-45</b>		45	9.330
<b>BOTA LONGA L-50</b>		50	9.330

REF.	DISEÑO/DESIGN	MEDIDAS / MEASUREMENTS (mm)	
		∅	gr.
BOTA LONGA L-55		55	9.330
BOTA J-420 YIMPA		40	6.000
BOTA J-420 R YIMPA		40	9.500
BOTA M-35 MARTORELL		35	5.200
BOTA M-40 MARTORELL		40	5.600
BOTA ZAZURCA Z-300		40	5.600
BOTA ZAZURCA Z-400		50	12.500
BOTA H-300 HALCON		50	6.000

# ACCESORIOS PARA CULTIVADORES

Cultivators accesories / Accessoires pour cultivateurs

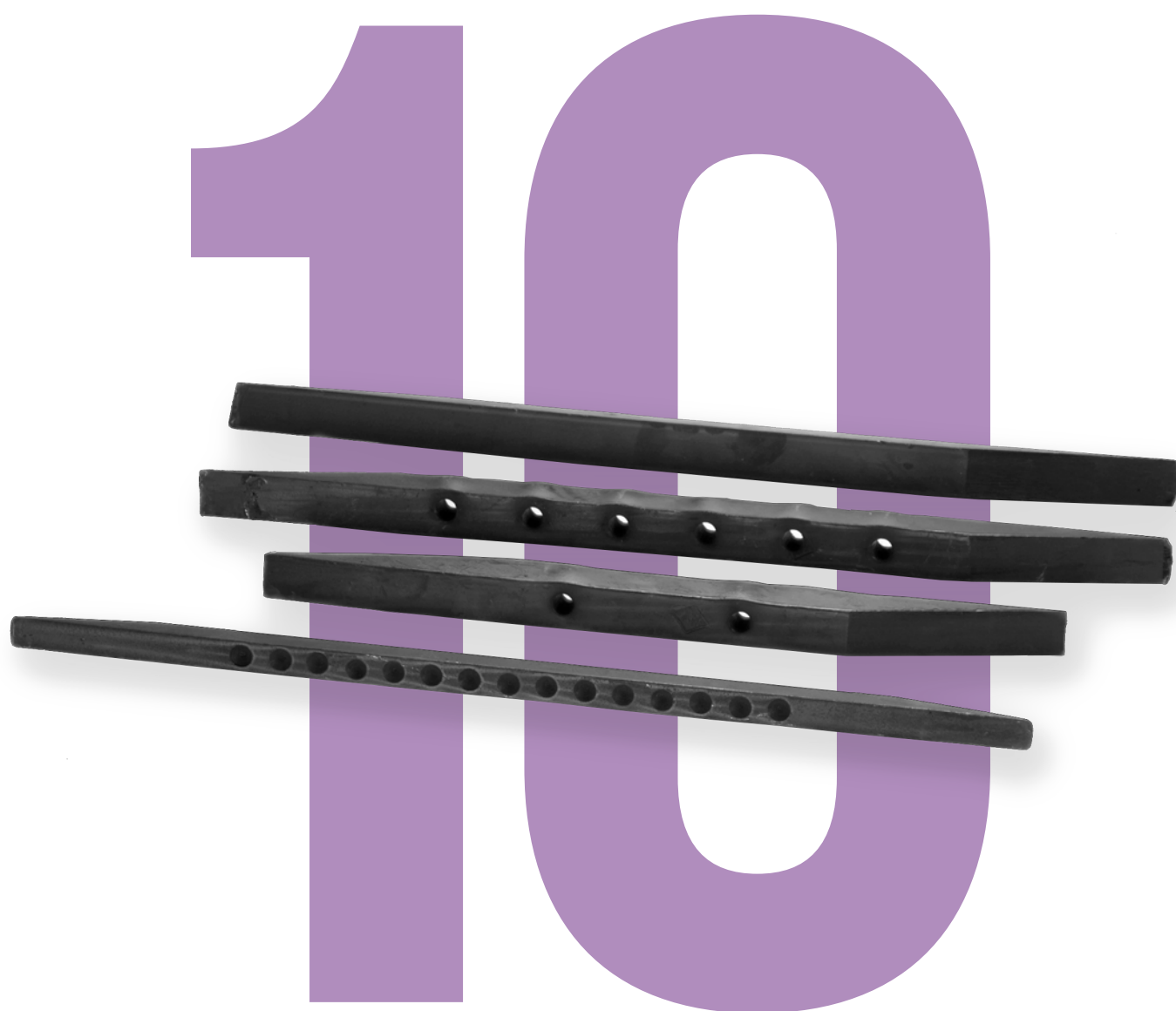

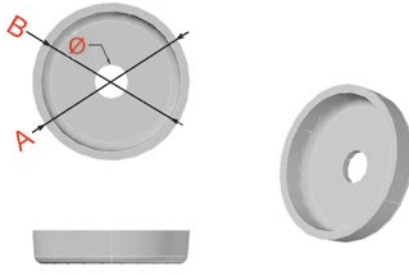
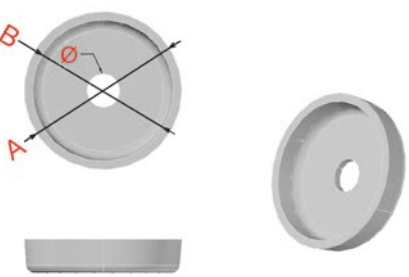
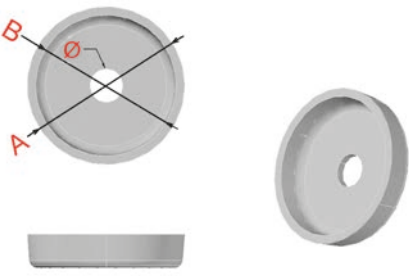
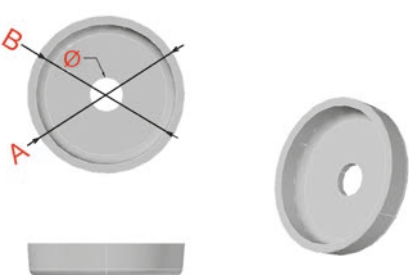
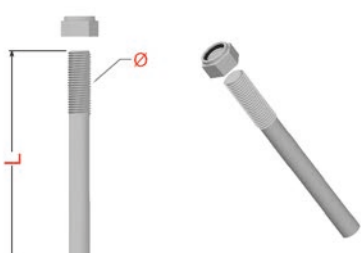

REF.	DISEÑO/DESIGN	MEDIDAS / MEASUREMENTS (mm)				
		A	B	T	∅	gr.
CAZUELETA		82	73	5	25	0,360
CAZUELETA		85	75	5	25	0,360
CAZUELETA		95	85	5	25	0,420
CAZUELETA		115	105	5	25	0,700
VARILLA PARA MUELLE		22mm con rosca de 24 mm	—	420	—	0,100 1,250

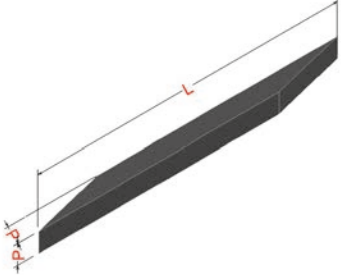
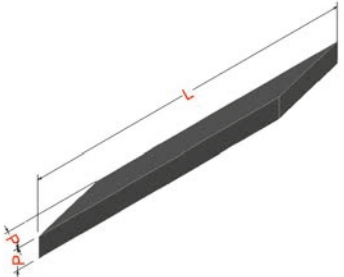
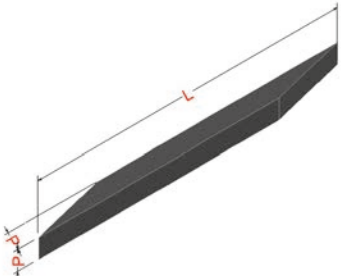
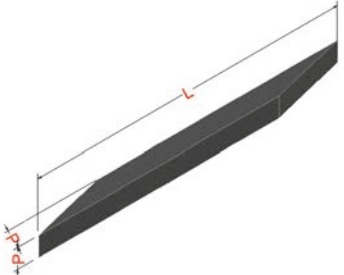
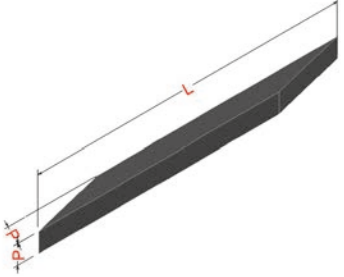
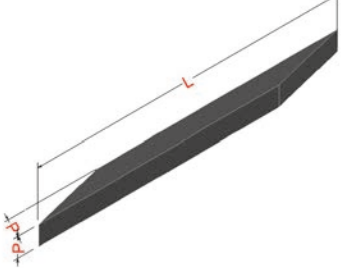
REF.	DISEÑO/DESIGN	MEDIDAS / MEASUREMENTS (mm)				
		P	L	∅	D.C.	gf
FORMON S/TALADRO		25X25	500	—	—	1.900
FORMON S/ TALADRO		25X25	600	—	—	2.460
FORMON S/ TALADRO		25X25	800	—	—	2.690
FORMON S/ TALADRO		30x30	200	—	—	2.450
FORMON S/ TALADRO		30x30	500	—	—	2.680
FORMON S/ TALADRO		30x30	600	—	—	3.500

P= PERFIL L= LARGO D.C = DISTANCIA ENTRE CENTROS / P= PROFILE L= LENGTH D.C= DIST. BETWEEN CENTERS

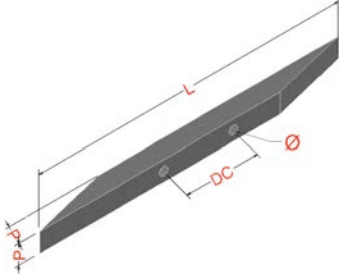
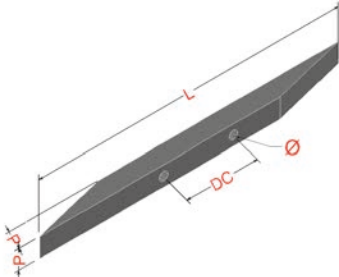
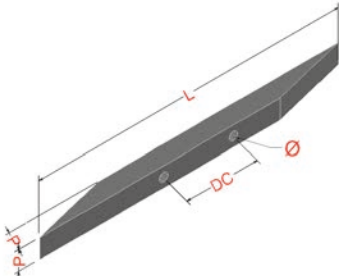
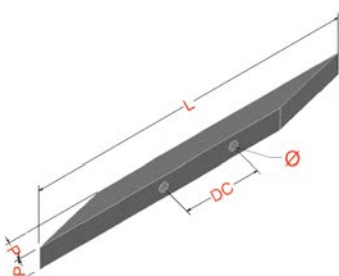
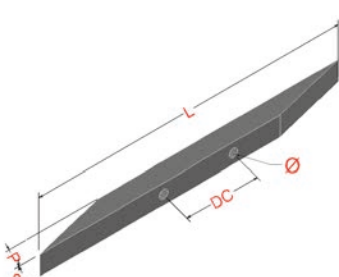
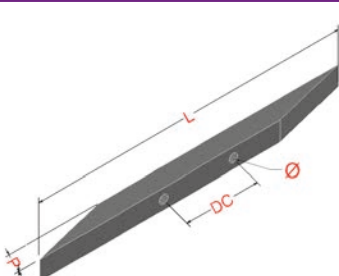
REF.	DISEÑO/DESIGN	MEDIDAS / MEASUREMENTS (mm)				
		P	L	Ø	D.C.	gr.
FORMON		30x30	500	13	125	2.660
FORMON		30x30	500	13	110	2.660
FORMON		30x30	500	13	105	2.660
FORMON		30x30	500	13	115	2.660
FORMON		30x30	500	13	120	2.660
FORMON		30x30	500	13	130	2.660

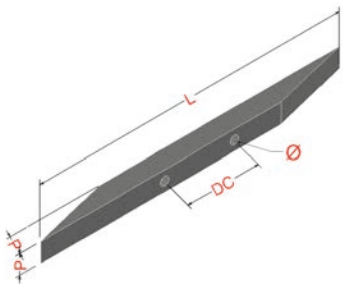
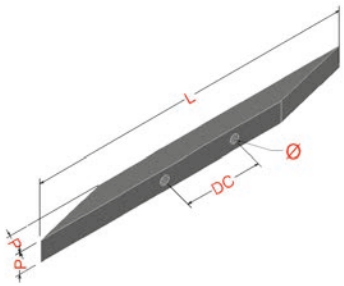
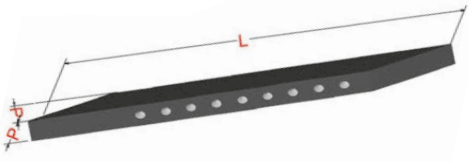
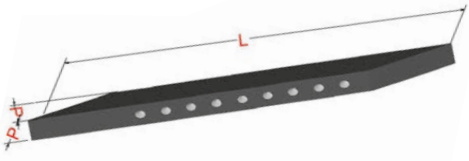
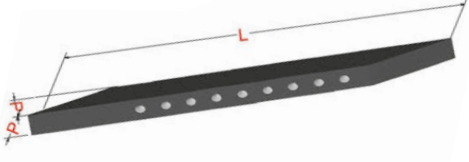
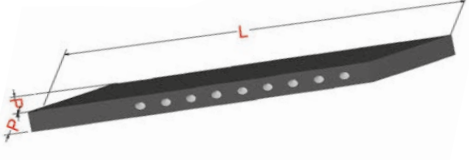
REF.	DISEÑO/DESIGN	MEDIDAS / MEASUREMENTS (mm)				
		P	L	Ø	D.C.	gf.
FORMON		30x30	600	13	110	3.500
FORMON		30x30	600	13	115	3.500
FORMON AVELLANADO		28x28	800	—	—	4.200
FORMON AVELLANADO		30x30	900	—	—	5.900
FORMON AVELLANADO		32x32	900	—	—	6.300
FORMON AVELLANADO		34x34	900	—	—	6.925

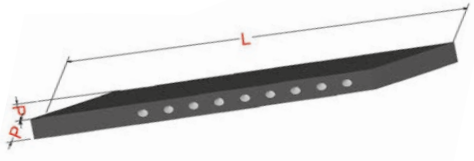
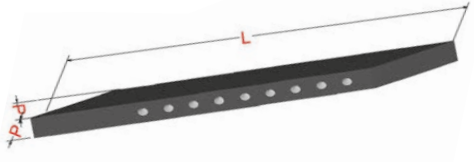
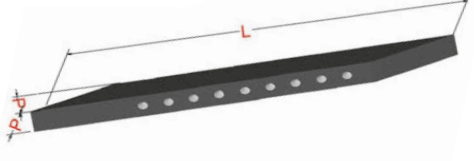
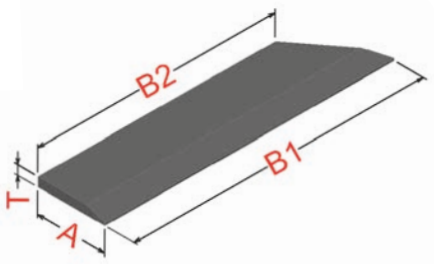
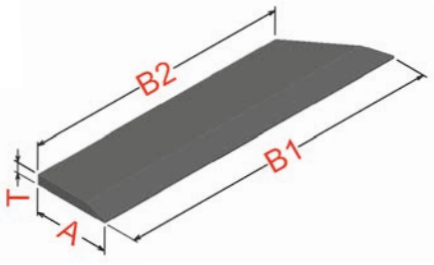
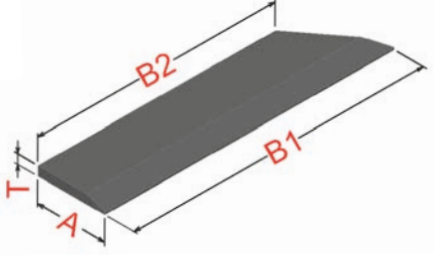
REF.	DISEÑO/DESIGN	MEDIDAS / MEASUREMENTS (mm)				
		P	L	Ø	D.C.	gr.
<b>FORMON AVELLANADO</b>		35x35	900	—	—	7.150
<b>FORMON AVELLANADO</b>		38x38	900	—	—	8.525
<b>FORMON AVELLANADO</b>		40x40	1.000	—	—	9.925
REFERENCE	ALETAS / SPARE PARTS					
<b>ALETA N° 3</b>		A	T	B1	B2	gr.
		55	6	200	165	0,460
<b>ALETAS N° 21</b>		A	T	B1	B2	gr.
		50	10	200	145	0,660
<b>ALETA N° 22</b>		A	T	B1	B2	gr.
		50	8	250	205	0,700

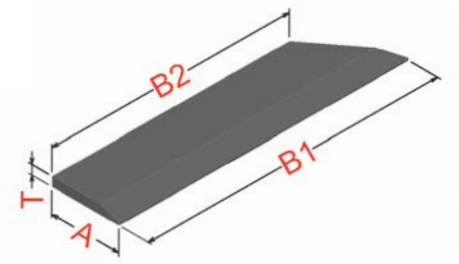
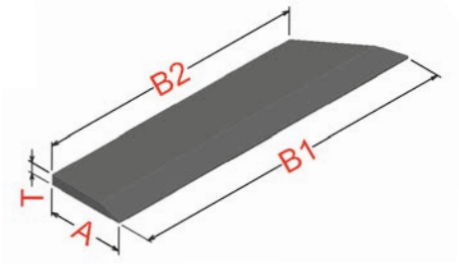
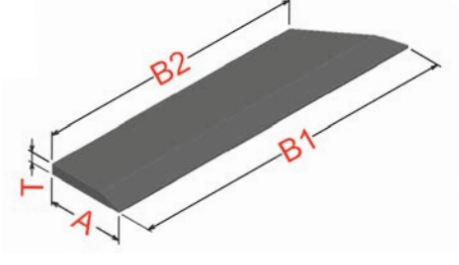
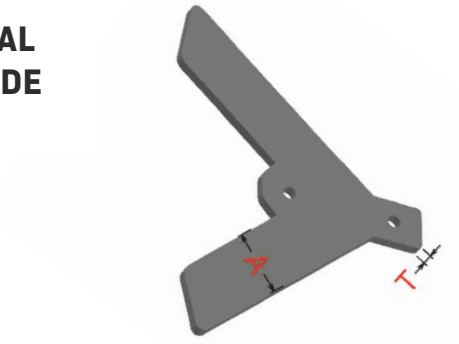
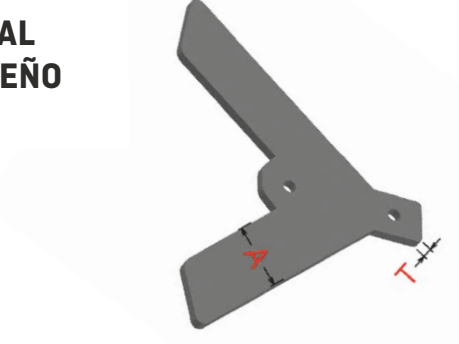
REF.	DISEÑO/DESIGN	MEDIDAS / MEASUREMENTS (mm)				
		A	T	B1	B2	gf.
<b>ALETA N° 23</b>		50	8	210	145	0,540
<b>ALETA N° 28</b>		50	8	285	225	1.130
<b>ALETA N° 34</b>		50	12	270	210	1.060
<b>DENTAL GRANDE</b>		60	8	—	—	2.060
<b>DENTAL PEQUEÑO</b>		55	8	—	—	1.500





# **BRAZOS PARA CULTIVADORES**

**Tines for cultivators / Bras pour cultivateurs**

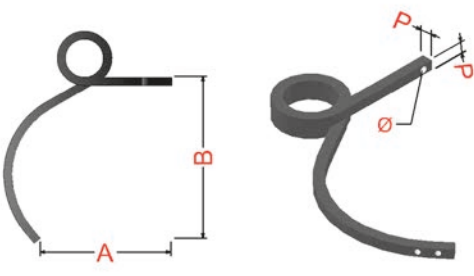
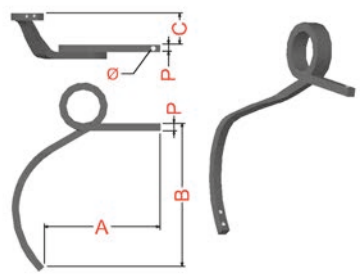
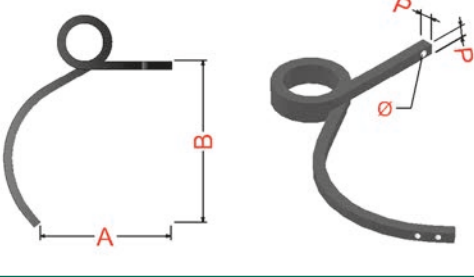
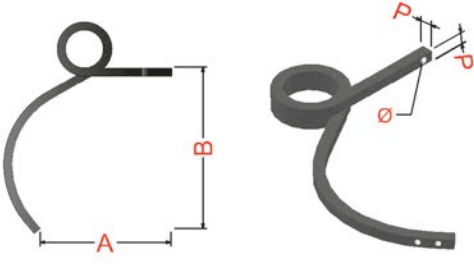
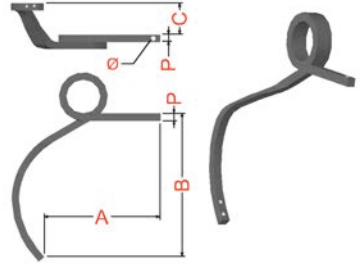

REF.	DISEÑO/DESIGN	MEDIDAS / MEASUREMENTS (mm)					
		A	B	C	P	BOLT	
<b>C-20/12</b>		370	430	—	20x20	12	4.380
<b>C-20/12 V-ACODADO</b>		370	430	180	20x20	12	4.800
<b>C-20/14</b>		370	430	—	20x20	14	4.380
<b>C-25/16</b>		395	490	—	25x25	16	8.640
<b>C-25/16 V-ACODADO</b>		395	490	240	25x25	16	8.880

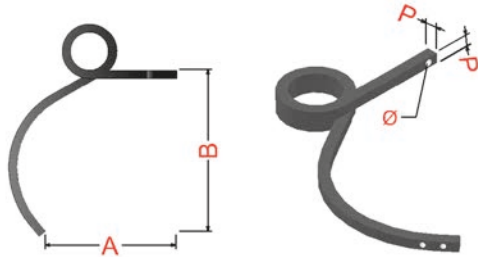
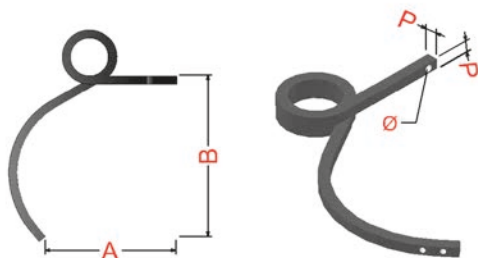
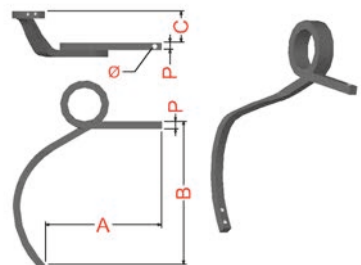
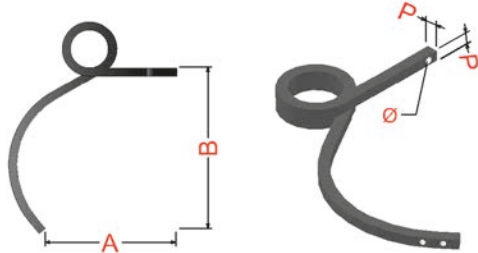
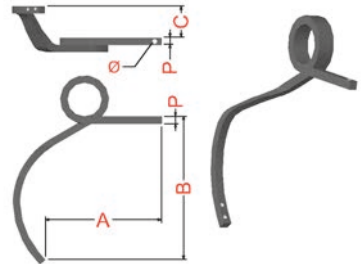
REF.	DISEÑO/DESIGN	MEDIDAS / MEASUREMENTS (mm)					
		A	B	C	P	BOLT	gr.
<b>C-27/16</b>		410	545	—	27x27	16	10.470
<b>C-27/22</b>		410	545	—	27x27	22	10.470
<b>C-27/16 V-ACODADO</b>		410	545	280	27x27	16	11.220
<b>C-32/22</b>		455	555	—	32x32	22	17.520
<b>C-32/22 V-ACODADO</b>		455	555	330	32x32	22	18.250











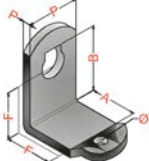

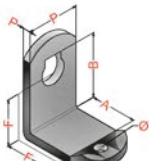

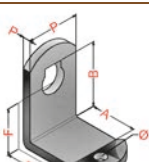

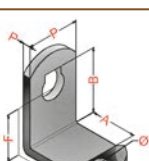

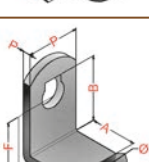

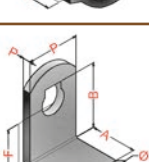

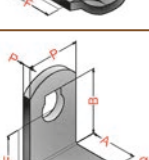

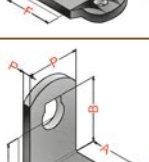

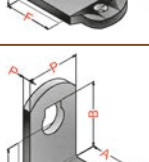
# **BRIDAS PARA BRAZOS EN ESPIRAL**

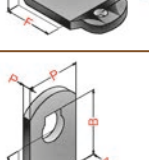
**Brackets for double coil spring tines**

**Brides pour bras en spirale**

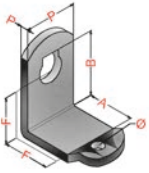
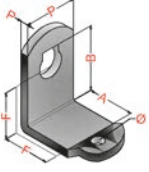

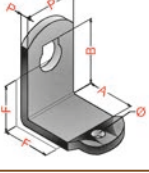
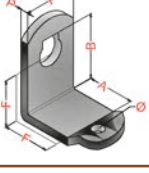
REF.	DISEÑO/DESIGN	MEDIDAS / MEASUREMENTS (mm)					
<b>BRIDA BRAZO DE 20</b>		A	B	F	BOLT	P	
		50	70	50 x 50	12	60 x 10	0,690
<b>BRIDA BRAZO DE 20</b>		A	B	F	BOLT	P	
		60	45	60 x 25	12	60 x 10	0,640
<b>BRIDA BRAZO DE 20</b>		A	B	F	BOLT	P	
		60	50	60 x 30	12	60 x 10	0,660
<b>BRIDA BRAZO DE 20</b>		A	B	F	BOLT	P	
		60	80	60 x 60	12	60 x 10	0,790
<b>BRIDA BRAZO DE 20</b>		A	B	F	BOLT	P	
		70	90	70 x 70	12	60 x 10	0,890
<b>BRIDA BRAZO DE 25</b>		A	B	F	BOLT	P	
		50	75	50 x 50	16	70 x 10	0,860
<b>BRIDA BRAZO DE 25</b>		A	B	F	BOLT	P	
		60	85	60 x 60	16	70 x 10	1,000
<b>BRIDA BRAZO DE 25</b>		A	B	F	BOLT	P	
		70	95	70 x 70	16	70 x 10	1,500
<b>BRIDA BRAZO DE 25</b>		A	B	F	BOLT	P	
		80	105	80 x 80	16	70 x 10	1,200
<b>BRIDA BRAZO DE 27</b>		A	B	F	BOLT	P	
		50	77	50 x 50	16	80 x 12	1,360

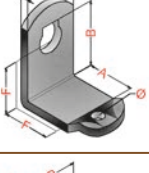
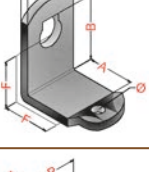
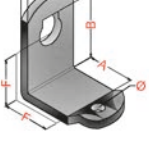
REF.	DISEÑO/DESIGN	MEDIDAS / MEASUREMENTS (mm)					
		A	B	F	BOLT	P	gr.
<b>BRIDA BRAZO DE 27</b>		60	87	60 x 60	16	80 x 12	1.400
<b>BRIDA BRAZO DE 27</b>		70	97	70 x 70	16	80 x 12	1.500
<b>BRIDA BRAZO DE 27</b>		80	87	80 x 60	16/22	80 x 12	1.520
<b>BRIDA BRAZO DE 27</b>		80	107	80 x 80	16/22	80 x 12	1.690
<b>BRIDA BRAZO DE 27</b>		100	127	100 x 100	16	80 x 12	2.000
<b>BRIDA BRAZO DE 27</b>		100	87	100 x 60	16	80 x 12	2.000
<b>BRIDA BRAZO DE 32</b>		60	92	60 x 60	22	90 x 12	1.660
<b>BRIDA BRAZO DE 32</b>		70	102	70 x 70	22	90 x 12	1.750
<b>BRIDA BRAZO DE 32</b>		80	92	80 x 60	22	90 x 12	1.760
<b>BRIDA BRAZO DE 32</b>		80	112	80 x 80	22	90 x 12	1.860





# **BRAZOS CHISEL**

Chisel tines / Bras ciseau

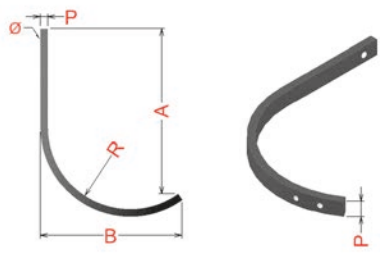
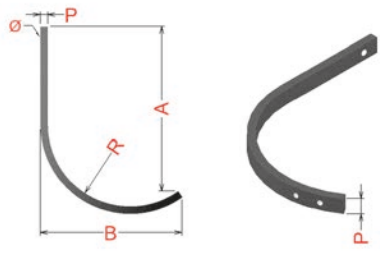
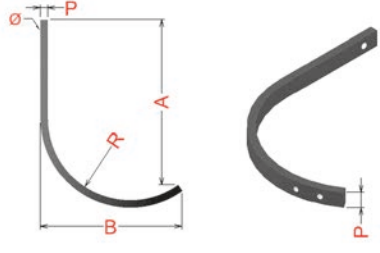
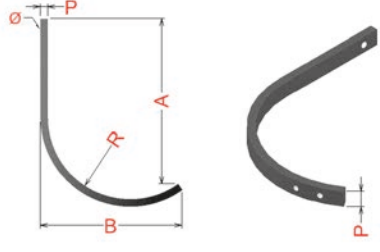
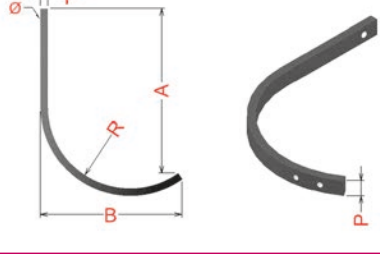
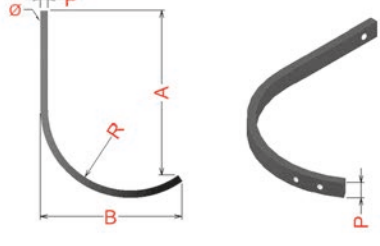

REF.	DISEÑO/DESIGN	MEDIDAS / MEASUREMENTS (mm)						
		P	A	B	R	C	BOLT	gf
<b>461-B</b>		45x20	460	395	230	—	16	5.500
<b>461-BL</b>		45X20	415	450	230	—	16	6.100
<b>461-BHC</b>		45X20	515	350	230	—	16	5.400
<b>461-C</b>		40x30	435	450	230	—	18	8.000
<b>461-D</b>		40x30	475	530	305	—	18	8.600
<b>461-E</b>		40X30	525	440	275	—	18	8.000

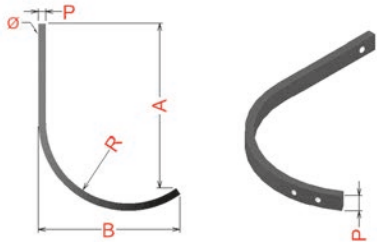
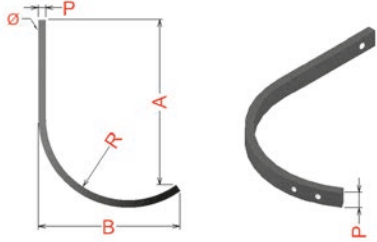
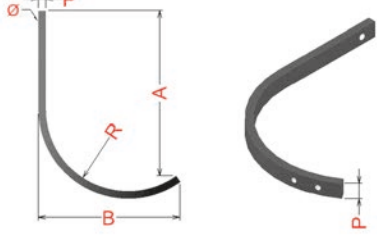
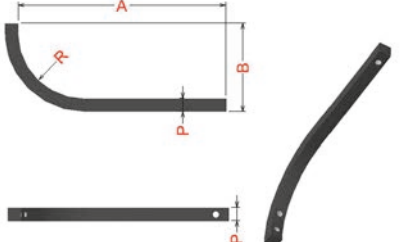
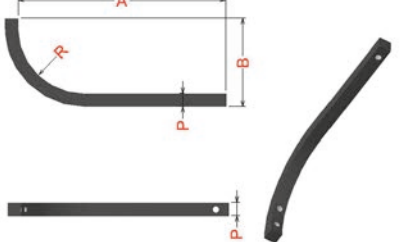
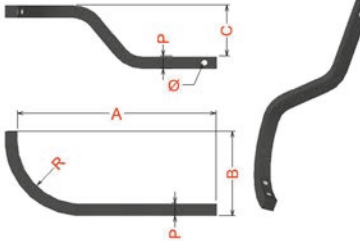
REF.	DISEÑO/DESIGN	MEDIDAS / MEASUREMENTS (mm)						
		P	A	B	R	C	BOLT	gfr
<b>461-F</b>		40x30	490	390	235	—	18	7.400
<b>462-A</b>		50x25	460	597	305	—	20	10.600
<b>462-B</b>		50x30	440	615	305	—	20	12.500
<b>464-A</b>		20x20	360	300	235	—	12	1.700
<b>464-B</b>		30x30	430	415	235	—	16	5.400
<b>464-B/V</b>		30x30	430	415	235	190	16	5.950

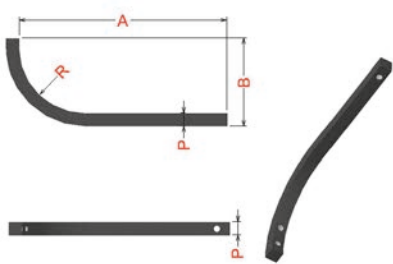
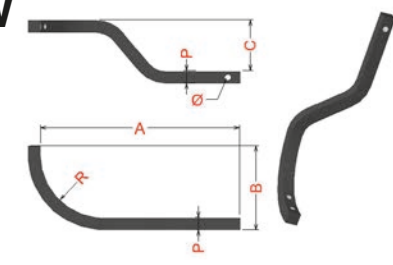
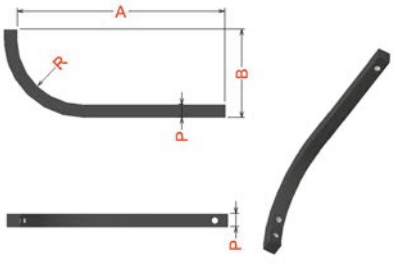
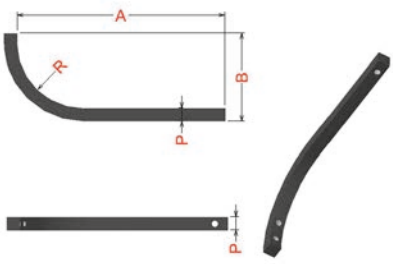
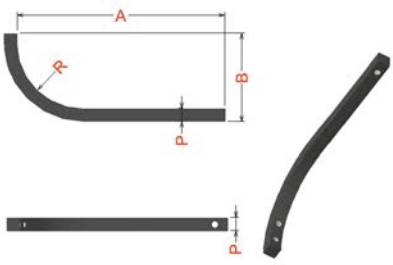
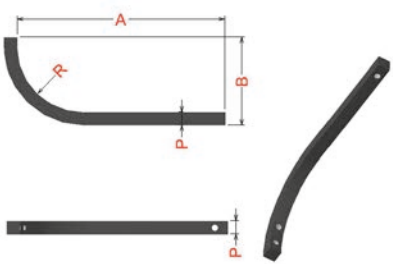
REF.	DISEÑO/DESIGN	MEDIDAS / MEASUREMENTS (mm)						
		P	A	B	R	C	BOLT	gf
<b>464-C</b>		32x32	400	340	205	—	14	5.050
<b>464-C/V</b>		32x32	400	340	205	140	14	5.530
<b>464-L</b>		32x32	525	440	275	—	16	6.800
<b>464-LA</b>		32x32	375	530	295	—	18	6.700
<b>464-H</b>		35x35	375	530	295	—	18	7.800
<b>464-I</b>		35x35	475	530	305	—	18	8.650

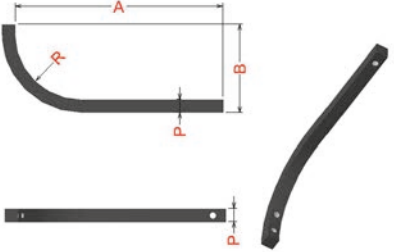
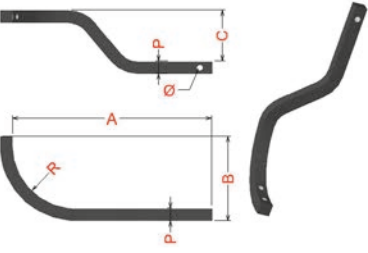
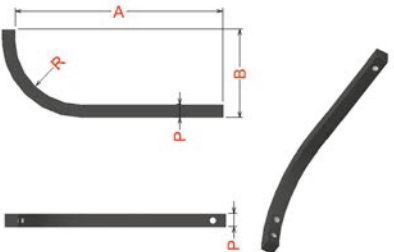
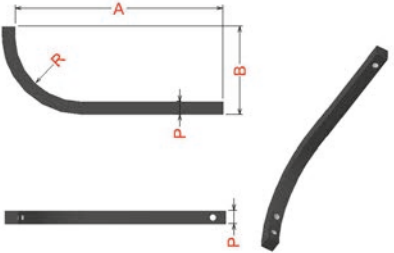
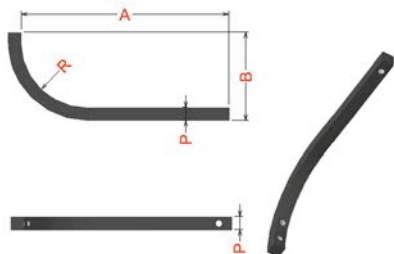
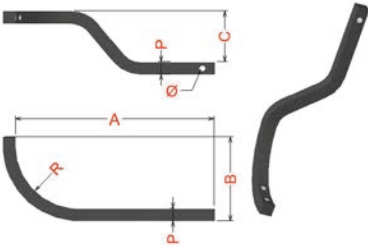
REF.	DISEÑO/DESIGN	MEDIDAS / MEASUREMENTS (mm)						
		P	A	B	R	C	BOLT	gr.
<b>464-D</b>		40x40	460	540	295	—	24	11.470
<b>464-D/V</b>		40X40	460	540	295	260	24	12.600
<b>464-E</b>		25X25	365	315	230	—	14	2.750
<b>464-F</b>		25x25	390	345	205	—	14	3.200
<b>464-AL</b>		40X40	525	590	340	—	24	12.600
<b>464-AL/V</b>		40X40	525	590	340	260	24	13.350







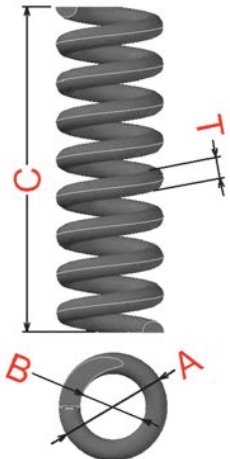

# MUELLES DE COMPRESION

Compression springs / Ressorts de compression

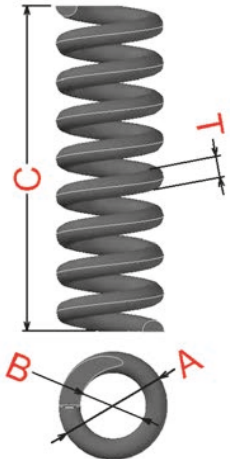

REF.	DISEÑO/DESIGN	MEDIDAS / MEASUREMENTS (mm)					
		A	B	C	T	N° SPIRALS	gr.
MUELLES		55	33	180	12	9	1.000
		A	B	C	T	N° SPIRALS	gr.
		65	39	185	13	9	1.480
		A	B	C	T	N° SPIRALS	gr.
		72	43	270	14	12	2.520
		A	B	C	T	N° SPIRALS	gr.
MUELLES		75	45	250	15	11	2.710
		A	B	C	T	N° SPIRALS	gr.
		78	51	270	16	12	3.470
		A	B	C	T	N° SPIRALS	gr.
		80	48	230	16	10	2.980
		A	B	C	T	N° SPIRALS	gr.
MUELLES		80	51	270	14	12	3.550
		A	B	C	T	N° SPIRALS	gr.
		100	62	250	18	9	4.190
		A	B	C	T	N° SPIRALS	gr.

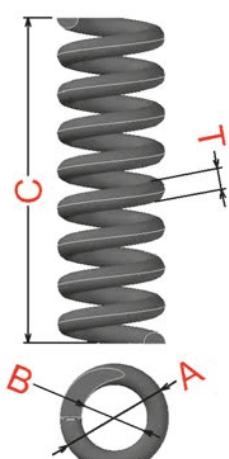
A = DIÁMETRO EXTERNO B= DIÁMETRO INTERNO C= LARGO T= ESPESOR CLAVILLA / A= EXTERNAL DIAMETER B= INTERNAL DIAMETER C= LENGTH T= THICKNESS

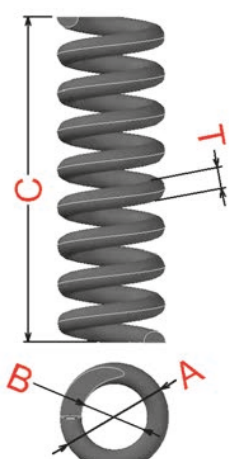
REF.	DISEÑO/DESIGN	MEDIDAS / MEASUREMENTS (mm)					
		A	B	C	T	N° SPIRALS	gr.
MUELLES		78	30	305	15	13	3.400
		A	B	C	T	N° SPIRALS	gr.
		100	70	300	16	11	4.380
		A	B	C	T	N° SPIRALS	gr.
		70	42	200	14	8	1.550
		A	B	C	T	N° SPIRALS	gr.
MUELLES		80	47	220	16	10	3.020
		A	B	C	T	N° SPIRALS	gr.
		100	62	250	18	9	4.190
		A	B	C	T	N° SPIRALS	gr.
		98	60	270	20	10	5.700
		A	B	C	T	N° SPIRALS	gr.
MUELLES		100	70	300	16	11	4.240
		A	B	C	T	N° SPIRALS	gr.
		100	60	300	18	11	6.000
		A	B	C	T	N° SPIRALS	gr.

A = DIÁMETRO EXTERNO B= DIÁMETRO INTERNO C= LARGO T= ESPESOR CLAVILLA / A= EXTERNAL DIAMETER B= INTERNAL DIAMETER C= LENGTH T= THICKNESS









## **DISCOS DE GRADA Y ARADO**

**Harrow and plough discs / Herses à disques et charrue**



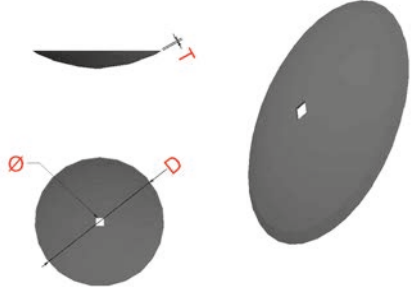

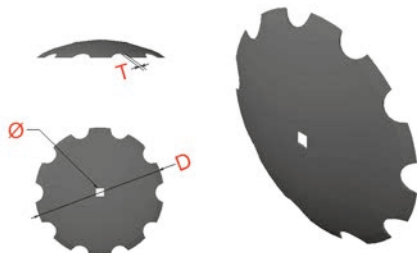
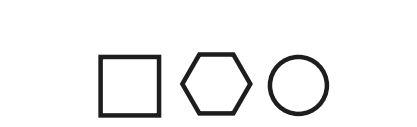
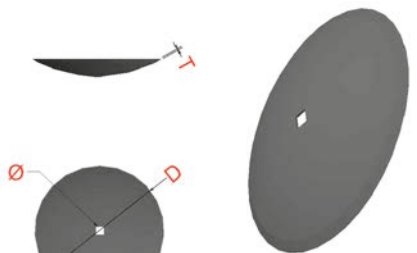

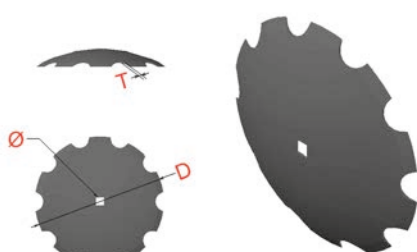
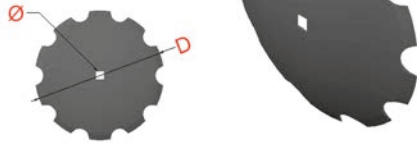



REF.	DISEÑO/DESIGN	MEDIDAS / MEASUREMENTS (mm)				
		T	D	C	gr. LISO	gr. DENTADO
D-0/906-16"		3,25	410	670	3.347	3.046
D-1/906-18"		3,25	460	670	4.200	3.800
D-2/906-20"		3,50	510	670	5.700	5.200
D-2/906-20"		4	510	670	6.500	5.900
D-3/906-22"		4	560	670	7.640	6.755
D-3/906-22"		5	560	670	8.600	7.600
D-4/906-24"		5	610	670	12.000	10.800
D-4/906-24"		6	610	670	15.000	13.000

T = ESPESOR D = DIAMETRO C = RADIO / T = THICKNESS D = DIAMETER C = RADIUS LISO = PLAIN DENTADO = NOTCHED

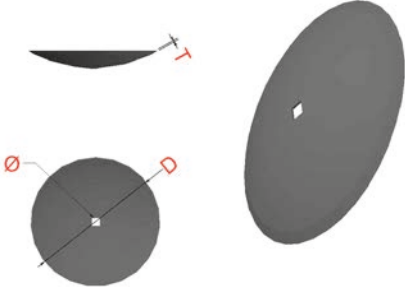

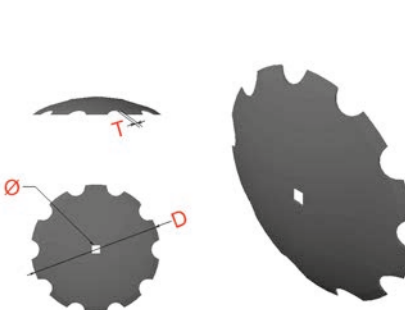

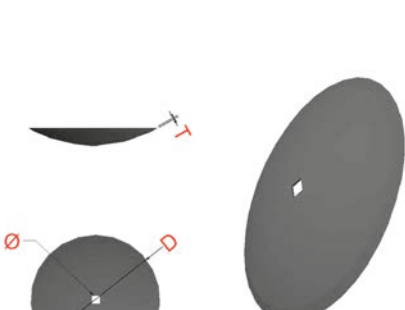
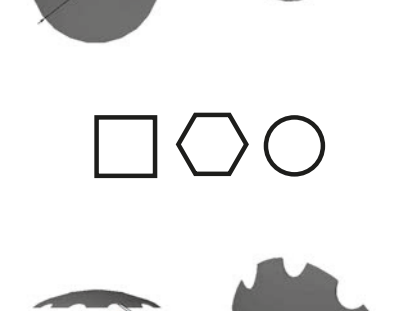

REF.	DISEÑO/DESIGN	MEDIDAS / MEASUREMENTS (mm)				
		T	D	C	 LISO	 DENTADO
D-5/906-26"		6	660	670	17.500	15.600
D-5/906-26"		8	660	670	23.300	20.800
D-6/906-28"		6	710	670	21.000	18.300
D-6/906-28"		8	710	670	27.000	25.000
D-7/906-30"		8	760	670	30.000	28.000
D-59/909-32"		10	810	820	44.000	41.000
D-60/909-36"		12	914	820	67.000	63.000
D-7/908-16"		3,25	410	585	3.347	3.046

T = ESPESOR D = DIAMETRO C = RADIO / T = THICKNESS D = DIAMETER C = RADIUS LISO= PLAIN DENTADO= NOTCHED



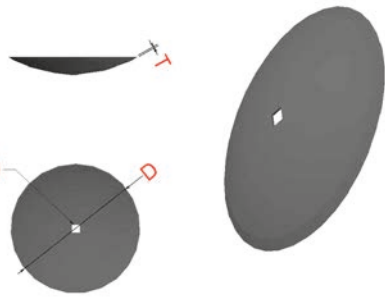
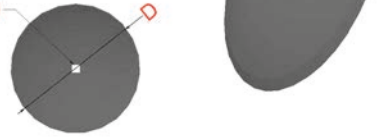

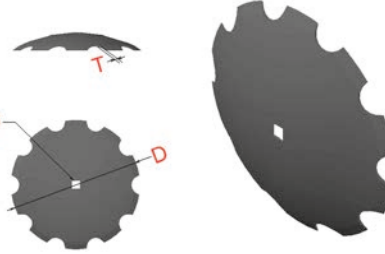
REF.	DISEÑO/DESIGN	MEDIDAS / MEASUREMENTS (mm)				
		T	D	C	 LISO	 DENTADO
D-8/908-18"		5	460	585	6.461	5.846
D-8/908-18"		3,25	460	585	4.200	3.800
D-9/908-20"		4	510	585	6.500	5.900
D-9/908-20"		5	510	585	8.125	7.375
D-9/908-20"		6	510	585	9.750	8.850
D-10/908-22"		4,50	560	585	8.600	7.600
D-10/908-22"		6	560	585	11.466	10.133
D-11/908-24"		5	610	585	12.000	10.800

T = ESPESOR D= DIAMETRO C= RADIO / T= THICKNESS D= DIAMETER C= RADIUS LISO= PLAIN DENTADO= NOTCHED

REF.	DISEÑO/DESIGN	MEDIDAS / MEASUREMENTS (mm)				
		T	D	C	 LISO	 DENTADO
D-11/908-24"		6	610	585	15.000	13.000
D-12/908-26"		6	660	585	17.500	15.600
D-12/908-26"		8	660	585	23.300	20.800
D-13/908-28"		6	710	585	21.000	18.030
D-13/908-28"		8	710	585	27.000	25.000
D-14/908-30"		8	760	585	30.000	28.000

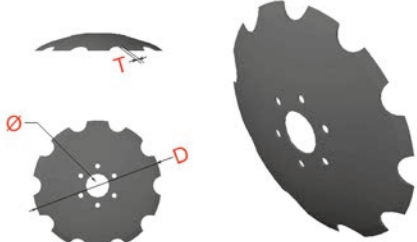
DISCOS GRADA RÁPIDA / HARROW DISCS FAST



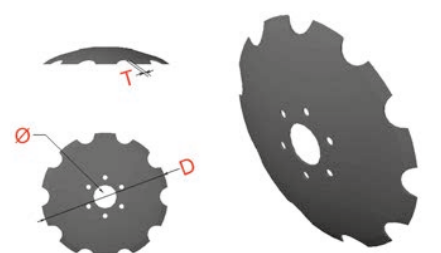



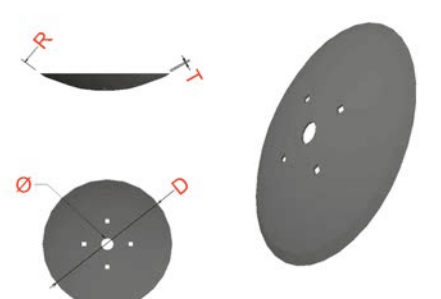
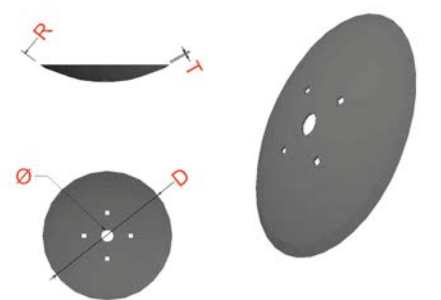
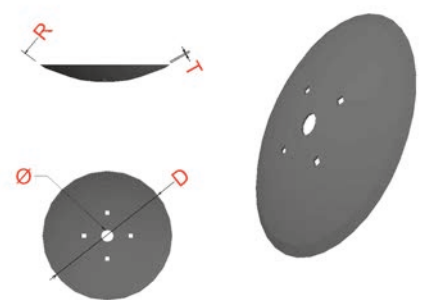

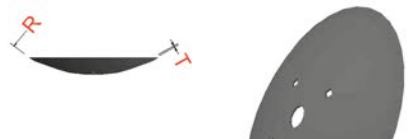
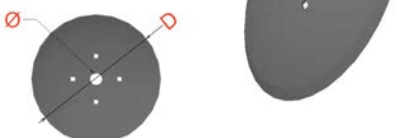

REF.	DISEÑO/DESIGN	MEDIDAS / MEASUREMENTS (mm)			
		T	D	C	 DENTADO
D-2/904-20"		6	510	740	8.850
D-3/904-22"		6	560	740	10.130

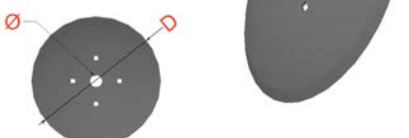
REF.	DISEÑO/DESIGN	MEDIDAS / MEASUREMENTS (mm)			
		T	D	C	 DENTADO
D-4/904-24"		6	610	740	13.000
D-5/904-26"		6	660	740	15.600

DISCOS PARA ARADO / PLOUGH DISCS

REF.	DISEÑO/DESIGN	MEDIDAS / MEASUREMENTS (mm)			
		T	D	C	 LISO
D-21/913-20"		4	510	670	6.500
D-21/913-22"		5	560	670	10.000
D-22/913-24"		5	610	670	12.000
D-22/913-24"		6	610	670	15.000
D-23/913-26"		6	660	670	17.500
D-23/913-26"		8	660	670	23.300

T = ESPESOR D= DIAMETRO C= RADIO / T= THICKNESS D= DIAMETER C= RADIUS LISO= PLAIN DENTADO= NOTCHED

REF.	DISEÑO/DESIGN	MEDIDAS / MEASUREMENTS (mm)			
		T	D	C	gr. LISO
D-24/913-28"		6	710	670	21.000
D-24/913-28"		T	D	C	gr. LISO
					
D-25/913-30"		8	760	670	30.000
D-15/915-22"		T	D	C	gr. LISO
					
D-16/915-24"		5	610	585	12.000
D-16/915-24"		T	D	C	gr. LISO
					
D-17/915-26"		6	660	585	17.500
D-17/915-26"		T	D	C	gr. LISO
					







T = ESPESOR D= DIAMETRO C= RADIO / T= THICKNESS D= DIAMETER C= RADIUS LISO= PLAIN

REF.	DISEÑO/DESIGN	MEDIDAS / MEASUREMENTS (mm)			
		T	D	C	gr. LISO
D-18/915-28"		6	710	585	21.000
D-18/915-28"		T	D	C	gr. LISO
D-18/915-28"		8	710	585	27.000
		T	D	C	gr. LISO
D-19/915-30"		8	760	585	30.000
D-19/915-30"		T	D	C	gr. LISO
D-20/915-32"		10	810	820	44.000

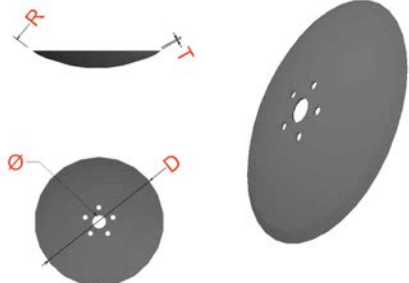
DISCOS ARADO 5 AGUJEROS + CENTRAL / PLOUGH DISCS 5 HOLES + CENTER HOLE

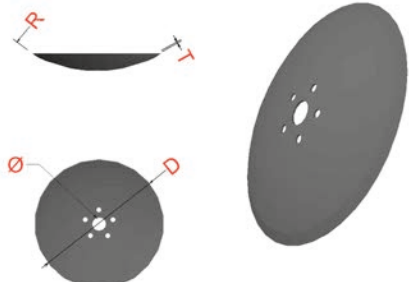
REF.	DISEÑO/DESIGN	MEDIDAS / MEASUREMENTS (mm)			
		T	D	C	gr. LISO
D-50/913-26"		6	660	670	17.500
D-50/913-26"		T	D	C	gr. LISO
D-50/913-26"		8	660	670	23.300
		T	D	C	gr. LISO
D-51/913-28"		6	710	670	21.000

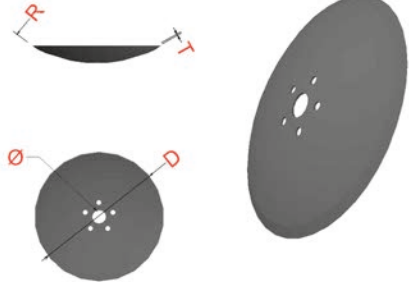
T = ESPESOR D= DIAMETRO C= RADIO / T= THICKNESS D= DIAMETER C= RADIUS LISO= PLAIN

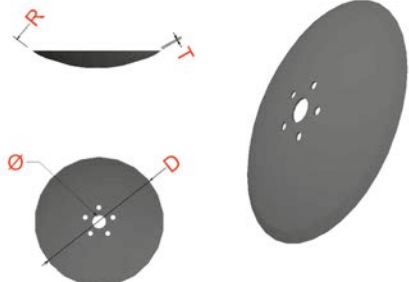
REF.	DISEÑO/DESIGN	MEDIDAS / MEASUREMENTS (mm)			
		T	D	C	gr. LISO
D-51/913-28"		8	710	670	27.000
D-41/913X1-30"		8	760	670	30.000
D-41/913X1-32"		8	810	820	35.200
D-55/915-26"		6	660	585	17.500
D-55/915-26"		8	660	585	23.300
D-56/915-28"		6	710	585	21.000
D-56/915-28"		8	710	585	27.000

T = ESPESOR D= DIAMETRO C= RADIO / T= THICKNESS D= DIAMETER C= RADIUS LISO= PLAIN











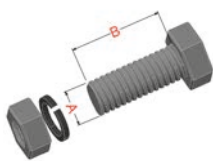
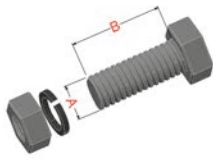
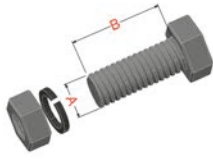
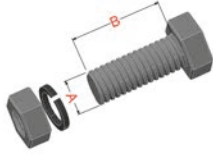
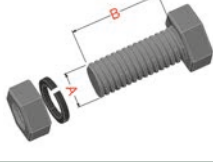
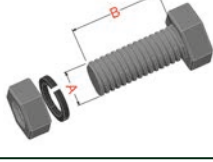
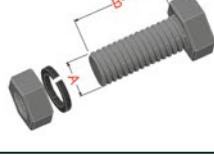

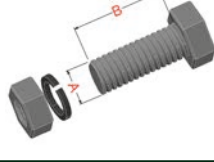
# TORNILLERIA AGRÍCOLA

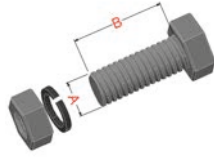
Agricultural bolts / Visserie agricole

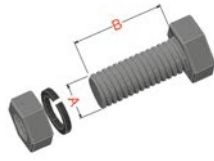

REF.	DISEÑO/DESIGN	MEDIDAS / MEASUREMENTS (mm)				
<b>8 X 25</b>		A	B	C	TUERCA	CALIDAD
<b>NORMA: DIN 933</b>		8	25			8.8
<b>8 X 30</b>		A	B	C	TUERCA	CALIDAD
<b>NORMA: DIN 933</b>		8	30			8.8
<b>10 X 30</b>		A	B	C	TUERCA	CALIDAD
<b>NORMA: DIN 933</b>		10	30			8.8
<b>10 X 40</b>		A	B	C	TUERCA	CALIDAD
<b>NORMA: DIN 931</b>		10	40			8.8
<b>12 X 30</b>		A	B	C	TUERCA	CALIDAD
<b>NORMA: DIN 933</b>		12	30			8.8
<b>12 X 70</b>		A	B	C	TUERCA	CALIDAD
<b>NORMA: DIN 931</b>		12	70			8.8
<b>1/2 X 38</b>	  OPCIONAL	A	B	C	TUERCA	CALIDAD
<b>NORMA: DIN 931</b>		1/2	38		AUTOBLOCANTE	8.8
<b>1/2 X 40</b>	  OPCIONAL	A	B	C	TUERCA	CALIDAD
<b>NORMA: DIN 931</b>		1/2	40		AUTOBLOCANTE	8.8
<b>1/2 X 50</b>	  OPCIONAL	A	B	C	TUERCA	CALIDAD
<b>NORMA: DIN 931</b>		1/2	50		AUTOBLOCANTE	8.8
<b>1/2 X 55</b>	  OPCIONAL	A	B	C	TUERCA	CALIDAD
<b>NORMA: DIN 931</b>		1/2	55		AUTOBLOCANTE	8.8

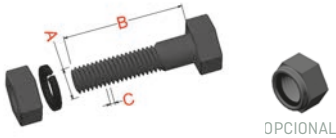
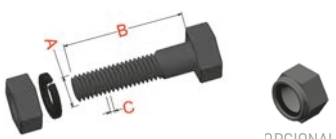
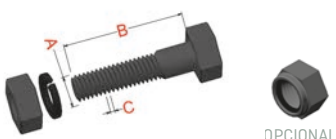
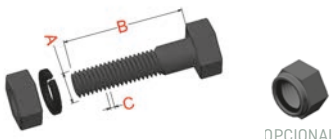
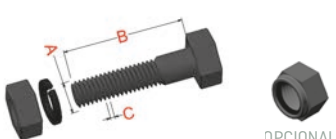
REF.	DISEÑO/DESIGN	MEDIDAS / MEASUREMENTS (mm)				
<b>7/16 X 35</b>		A	B	C	TUERCA	CALIDAD
<b>NORMA: DIN 931</b>		7/16	35		AUTOBLOCANTE	8.8
<b>14X150X45</b>		A	B	C	TUERCA	CALIDAD
<b>NORMA: DIN 931</b>		14	45	150 PASOFINO	AUTOBLOCANTE	10.9
<b>14X150X50</b>		A	B	C	TUERCA	CALIDAD
<b>NORMA: DIN 931</b>		14	50	150 PASOFINO	AUTOBLOCANTE	10.9
<b>14X150X55</b>		A	B	C	TUERCA	CALIDAD
<b>NORMA: DIN 931</b>		14	55	150 PASOFINO	AUTOBLOCANTE	8.8
<b>16X150X50</b>		A	B	C	TUERCA	CALIDAD
<b>NORMA: DIN 931</b>		16	50	150 PASOFINO	AUTOBLOCANTE	10.9
<b>16X150X55</b>		A	B	C	TUERCA	CALIDAD
<b>NORMA: DIN 931</b>		16	55	150 PASOFINO	AUTOBLOCANTE	8.8

TORNILLO AVELLANADO / COUNTERSUNK HEAD SQUARE NECK

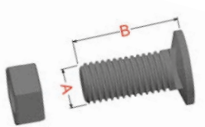
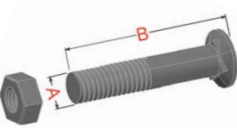
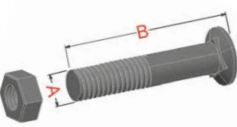
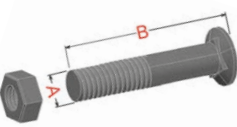
REF.	DISEÑO/DESIGN	MEDIDAS / MEASUREMENTS (mm)		
<b>8 X 25</b>		A	B	CALIDAD
<b>NORMA: DIN 608</b>		8	25	8.8 y 6.8
<b>10 X 40</b>		A	B	CALIDAD
<b>NORMA: DIN 608</b>		10	40	8.8 y 6.8
<b>10 X 50</b>		A	B	CALIDAD
<b>NORMA: DIN 608</b>		10	50	8.8 y 6.8
<b>11 X 40</b>		A	B	CALIDAD
<b>NORMA: DIN 608</b>		11	40	8.8 y 6.8

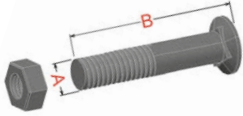
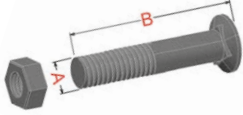
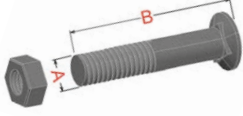
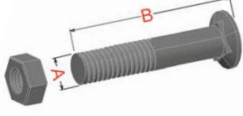
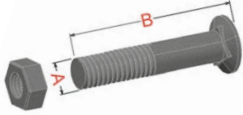
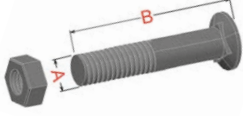
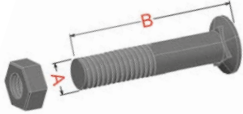
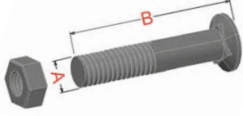
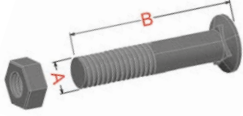
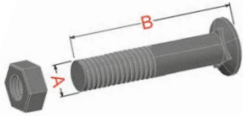
REF.	DISEÑO/DESIGN	MEDIDAS / MEASUREMENTS (mm)		
		A	B	CALIDAD
<b>11 X 45</b>				
<b>NORMA: DIN 608</b>		11	45	8.8 y 6.8
<b>11 X 50</b>				
<b>NORMA: DIN 608</b>		11	50	8.8 y 6.8
<b>11 X 60</b>				
<b>NORMA: DIN 608</b>		11	60	8.8 y 6.8
<b>11 X 70</b>				
<b>NORMA: DIN 608</b>		11	70	8.8 y 6.8
<b>11 X 80</b>				
<b>NORMA: DIN 608</b>		11	80	8.8 y 6.8
<b>11 X 90</b>				
<b>NORMA: DIN 608</b>		11	90	8.8 y 6.8
<b>12 X 40</b>				
<b>NORMA: DIN 608</b>		12	40	8.8 y 6.8
<b>12 X 50</b>				
<b>NORMA: DIN 608</b>		12	50	8.8 y 6.8
<b>12 X 60</b>				
<b>NORMA: DIN 608</b>		12	60	8.8 y 6.8
<b>12 X 70</b>				
<b>NORMA: DIN 608</b>		12	70	8.8 y 6.8

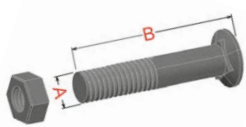
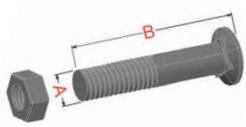
REF.	DISEÑO/DESIGN	MEDIDAS / MEASUREMENTS (mm)		
		A	B	CALIDAD
<b>12 X 80</b>		12	80	8.8 y 6.8
<b>NORMA: DIN 608</b>				
<b>12 X 90</b>		12	90	8.8 y 6.8
<b>NORMA: DIN 608</b>				

TORNILLERÍA HEXAGONAL / HEXAGON HEAD BOLTS

REF.	DISEÑO/DESIGN	MEDIDAS / MEASUREMENTS (mm)			
		A	B	TUERCA	CALIDAD
<b>12 X 40</b>		12	40	AUTOBLOCANTE	8.8
<b>NORMA: DIN 931</b>					
<b>12 X 50</b>		12	50	AUTOBLOCANTE	8.8
<b>NORMA: DIN 931</b>					
<b>12 X 60</b>		12	60	AUTOBLOCANTE	8.8
<b>NORMA: DIN 931</b>					
<b>12 X 70</b>		12	70	AUTOBLOCANTE	8.8
<b>NORMA: DIN 931</b>					
<b>12 X 80</b>		12	80	AUTOBLOCANTE	8.8
<b>NORMA: DIN 931</b>					
<b>12 X 90</b>		12	90	AUTOBLOCANTE	8.8
<b>NORMA: DIN 931</b>					
<b>12 X 100</b>		12	100	AUTOBLOCANTE	8.8
<b>NORMA: DIN 931</b>					
<b>12 X 110</b>		12	110	AUTOBLOCANTE	8.8
<b>NORMA: DIN 931</b>					

REF.	DISEÑO/DESIGN	MEDIDAS / MEASUREMENTS (mm)			
		A	B	TUERCA	CALIDAD
<b>12 X 120</b>		A	B	TUERCA	CALIDAD
<b>NORMA: DIN 931</b>	OPCIONAL	12	120	AUTOBLOCANTE	8.8
<b>12 X 130</b>		A	B	TUERCA	CALIDAD
<b>NORMA: DIN 931</b>	OPCIONAL	12	130	AUTOBLOCANTE	8.8
<b>14 X 30</b>		A	B	TUERCA	CALIDAD
<b>NORMA: DIN 931</b>	OPCIONAL	14	30	AUTOBLOCANTE	8.8
<b>14 X 40</b>		A	B	TUERCA	CALIDAD
<b>NORMA: DIN 931</b>	OPCIONAL	14	40	AUTOBLOCANTE	8.8
<b>14 X 50</b>		A	B	TUERCA	CALIDAD
<b>NORMA: DIN 931</b>	OPCIONAL	14	50	AUTOBLOCANTE	8.8
<b>14 X 60</b>		A	B	TUERCA	CALIDAD
<b>NORMA: DIN 931</b>	OPCIONAL	14	60	AUTOBLOCANTE	8.8
<b>14 X 70</b>		A	B	TUERCA	CALIDAD
<b>NORMA: DIN 931</b>	OPCIONAL	14	70	AUTOBLOCANTE	8.8
<b>14 X 80</b>		A	B	TUERCA	CALIDAD
<b>NORMA: DIN 931</b>	OPCIONAL	14	80	AUTOBLOCANTE	8.8
<b>14 X 90</b>		A	B	TUERCA	CALIDAD
<b>NORMA: DIN 931</b>	OPCIONAL	14	90	AUTOBLOCANTE	8.8
<b>14 X 100</b>		A	B	TUERCA	CALIDAD
<b>NORMA: DIN 931</b>	OPCIONAL	14	100	AUTOBLOCANTE	8.8
<b>14 X 110</b>		A	B	TUERCA	CALIDAD
<b>NORMA: DIN 931</b>	OPCIONAL	14	110	AUTOBLOCANTE	8.8

REF.	DISEÑO/DESIGN	MEDIDAS / MEASUREMENTS (mm)			
		A	B	TUERCA	CALIDAD
<b>14 X 120</b>					
<b>NORMA: DIN 931</b>	OPCIONAL	14	120	AUTOBLOCANTE	8.8
<b>14 X 130</b>					
<b>NORMA: DIN 931</b>	OPCIONAL	14	130	AUTOBLOCANTE	8.8
<b>14 X 140</b>					
<b>NORMA: DIN 931</b>	OPCIONAL	14	140	AUTOBLOCANTE	8.8
<b>16 X 40</b>					
<b>NORMA: DIN 931</b>	OPCIONAL	16	40	AUTOBLOCANTE	8.8
<b>16 X 50</b>					
<b>NORMA: DIN 931</b>	OPCIONAL	16	50	AUTOBLOCANTE	8.8
<b>16 X 60</b>					
<b>NORMA: DIN 931</b>	OPCIONAL	16	60	AUTOBLOCANTE	8.8
<b>16 X 80</b>					
<b>NORMA: DIN 931</b>	OPCIONAL	16	80	AUTOBLOCANTE	8.8
<b>16 X 90</b>					
<b>NORMA: DIN 931</b>	OPCIONAL	16	90	AUTOBLOCANTE	8.8
<b>16 X 100</b>					
<b>NORMA: DIN 931</b>	OPCIONAL	16	100	AUTOBLOCANTE	8.8
<b>16 X 110</b>					
<b>NORMA: DIN 931</b>	OPCIONAL	16	110	AUTOBLOCANTE	8.8
<b>16 X 120</b>					
<b>NORMA: DIN 931</b>	OPCIONAL	16	120	AUTOBLOCANTE	8.8



REF.	DISEÑO/DESIGN	MEDIDAS / MEASUREMENTS (mm)			
<b>16 X 130</b>		A	B	TUERCA	CALIDAD
<b>NORMA: DIN 931</b>	OPCIONAL	16	130	AUTOBLOCANTE	8.8
<b>16 X 140</b>		A	B	TUERCA	CALIDAD
<b>NORMA: DIN 931</b>	OPCIONAL	16	140	AUTOBLOCANTE	8.8
<b>18 X 50</b>		A	B	TUERCA	CALIDAD
<b>NORMA: DIN 931</b>	OPCIONAL	18	50	AUTOBLOCANTE	8.8
<b>18 X 70</b>		A	B	TUERCA	CALIDAD
<b>NORMA: DIN 931</b>	OPCIONAL	18	70	AUTOBLOCANTE	8.8
<b>18 X 90</b>		A	B	TUERCA	CALIDAD
<b>NORMA: DIN 931</b>	OPCIONAL	18	90	AUTOBLOCANTE	8.8
<b>18 X 120</b>		A	B	TUERCA	CALIDAD
<b>NORMA: DIN 931</b>	OPCIONAL	18	120	AUTOBLOCANTE	8.8
<b>18 X 150</b>		A	B	TUERCA	CALIDAD
<b>NORMA: DIN 931</b>	OPCIONAL	18	150	AUTOBLOCANTE	8.8
<b>18 X 180</b>		A	B	TUERCA	CALIDAD
<b>NORMA: DIN 931</b>	OPCIONAL	18	180	AUTOBLOCANTE	8.8
<b>20 X 50</b>		A	B	TUERCA	CALIDAD
<b>NORMA: DIN 931</b>	OPCIONAL	20	50	AUTOBLOCANTE	8.8
<b>20 X 130</b>		A	B	TUERCA	CALIDAD
<b>NORMA: DIN 931</b>	OPCIONAL	20	130	AUTOBLOCANTE	8.8
<b>22 X 100</b>		A	B	TUERCA	CALIDAD
<b>NORMA: DIN 931</b>	OPCIONAL	22	100	AUTOBLOCANTE	8.8

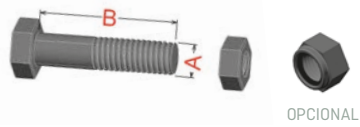
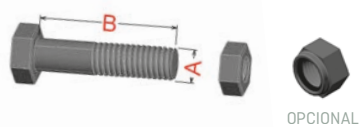
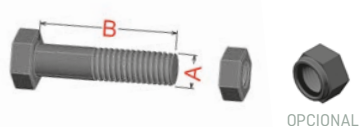
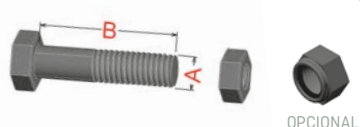
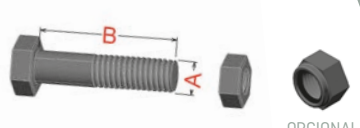

REF.	DISEÑO/DESIGN	MEDIDAS / MEASUREMENTS (mm)			
		A	B	TUERCA	CALIDAD
<b>22 X 110</b>					
<b>NORMA: DIN 931</b>		22	110	AUTOBLOCANTE	8.8
<b>22 X 120</b>					
<b>NORMA: DIN 931</b>		22	120	AUTOBLOCANTE	8.8
<b>22 X 130</b>					
<b>NORMA: DIN 931</b>		22	130	AUTOBLOCANTE	8.8
<b>22 X 140</b>					
<b>NORMA: DIN 931</b>		22	140	AUTOBLOCANTE	8.8
<b>22 X 150</b>					
<b>NORMA: DIN 931</b>		22	150	AUTOBLOCANTE	8.8

TORNILLOS CÓNICOS / CONICAL BOLTS

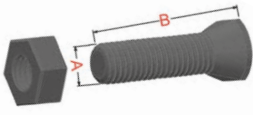
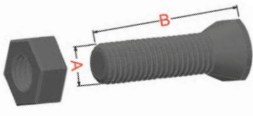
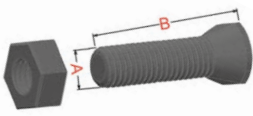
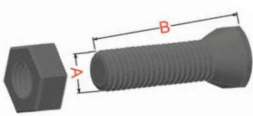
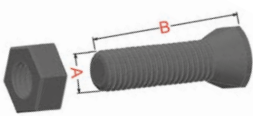
REF.	DISEÑO/DESIGN	MEDIDAS / MEASUREMENTS (mm)		
		A	B	CALIDAD
<b>12 X 33</b>				
<b>NORMA: DIN 604</b>		12	33	12.9
<b>12 X 37</b>				
<b>NORMA: DIN 604</b>		12	37	12.9
<b>12 X 40</b>				
<b>NORMA: DIN 604</b>		12	40	12.9
<b>12 X 42</b>				
<b>NORMA: DIN 604</b>		12	42	12.9
<b>12 X 52</b>				
<b>NORMA: DIN 604</b>		12	52	12.9

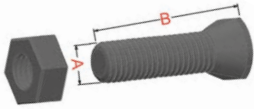
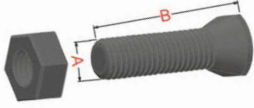
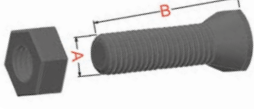
REF.	DISEÑO/DESIGN	MEDIDAS / MEASUREMENTS (mm)		
		A	B	CALIDAD
<b>14 X 33</b>				
NORMA: DIN 604		14	33	12.9
<b>14 X 37</b>				
NORMA: DIN 604		14	37	12.9
<b>14 X 42</b>				
NORMA: DIN 604		14	42	12.9

## TORNILLOS DOS PRISIONEROS / COUNTERSUNK HEAD TWO NIBS

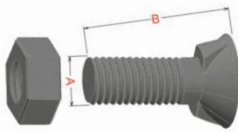
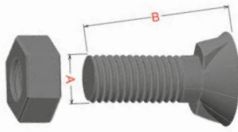
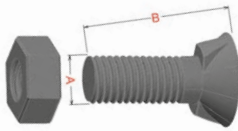
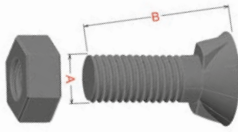
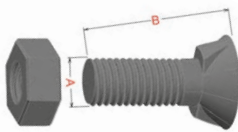
REF.	DISEÑO/DESIGN	MEDIDAS / MEASUREMENTS (mm)		
		A	B	CALIDAD
<b>12 X 35</b>				
NORMA: DIN 604		12	35	8.8
<b>12 X 40</b>				
NORMA: DIN 604		12	40	8.8
<b>12 X 50</b>				
NORMA: DIN 604		12	50	8.8
<b>14 X 40</b>				
NORMA: DIN 604		14	40	8.8
<b>14 X 45</b>				
NORMA: DIN 604		14	45	8.8







[www.agricolanavarro.com](http://www.agricolanavarro.com)



FABRICADO  
EN ESPAÑA



COMPROMISO  
AGRÍCOLA



CALIDAD  
DURADERA

**Agrícola Navarro Guevara, S.L.**

Ctra. Cartagena - Alhama de Murcia, km 27,700

30333 Cuevas del Reylo (Murcia) - España

Tlf. +34 968 151 245

Fax: +34 968 151 160

[comercial@agricolanavarro.com](mailto:comercial@agricolanavarro.com)